

Camera Manual

S26 Flex



201.001.01-02-EN_01/2021

THE MOBOTIX INFORMATION CHANNELS

MOBOTIX

BeyondHumanVision

Support on the MOBOTIX Website
www.mobotix.com/en/support



The MOBOTIX Video Tutorials
www.mobotix.com/en/support/download-center/documentation/video-tutorials



Seminars on MOBOTIX Campus
www.mobotix.com/en/support/trainings



The MOBOTIX YouTube Channel
www.youtube.com/user/MobotixAG



MOBOTIX Seminars

MOBOTIX offers inexpensive seminars that include workshops and practical exercises. For more information, visit www.mobotix.com > **Support** > **Trainings**.

Copyright Information

All rights reserved. *MOBOTIX*, the MX logo, *MxManagementCenter* and *MxPEG* are trademarks of MOBOTIX AG registered in the European Union, the U.S.A., and other countries. *Microsoft*, *Windows* and *Windows Server* are registered trademarks of Microsoft Corporation. *Apple*, the Apple logo, *Macintosh*, *OS X*, *iOS*, *Bonjour*, the Bonjour logo, the Bonjour icon, *iPod* and *iTunes* are trademarks of Apple Inc. registered in the U.S.A. and other countries. *iPhone*, *iPad*, *iPad mini* and *iPod touch* are Apple Inc. trademarks. *Linux* is a trademark of Linus Torvalds. All other marks and names mentioned herein are trademarks or registered trademarks of the respective owners.

Copyright © 1999-2021, MOBOTIX AG, Langmeil, Germany. Technical information subject to change without notice. MOBOTIX AG and its subsidiaries do not assume any liability for technical or editorial errors or omissions contained herein.

Download the latest version of this and other manuals as PDF files from www.mobotix.com > **Support** > **Download Center** > **Documentation** > **Manuals**.

TABLE OF CONTENTS

Safety Warnings	6
Legal Notes	7
Notes on System Security (“Cyber Security”)	7
Foreword	8
1 Product Overview	10
1.1 S26 – Lenses, Hardware, Image Formats	10
1.2 S26 – Software Features	11
1.3 S26 – Technical Data	12
1.4 S26 – Delivered Parts and Dimensions	14
1.4.1 The S26 Camera	14
1.5 Available Accessories	20
1.5.1 MiniUSB Cable to MiniUSB (Straight/Straight or Straight/Angled)	20
1.5.2 MiniUSB Cable to USB a Socket	20
1.5.3 Ethernet Patch Cable for Bayonet Catch	20
1.5.4 NPA-PoE-Set	20
1.5.5 MX-Overvoltage-Protection-Box	21
1.5.6 MX-NPA-Box	21
1.5.7 MX-GPS-Box	21
1.5.8 MX-232-IO-Box	22
1.5.9 ExtIO Expansion Module	22
1.5.10 Mx2wire+ Media Converter	22
1.5.11 AudioMount	23
1.5.12 SpeakerMount	23
1.5.13 Other Accessories	24
1.6 MOBOTIX Software	25
1.6.1 Integrated Camera Software (Firmware)	25
1.6.2 MxManagementCenter	26
1.6.3 MOBOTIX MxBell	27

2	Installation	28
2.1	Preparing the Installation	29
2.2	Before Mounting	30
2.2.1	Overview of Cable Connections	30
2.2.2	Notes on Cable Lengths and Power Supply	32
2.2.3	Network Connection with MOBOTIX Patch Cable	33
2.2.4	Network Connection with Installation Cable	34
2.2.5	Using the MiniUSB Cable	34
2.2.6	Using MxBus Modules	35
2.2.7	External Audio Support (Microphone/Speaker)	35
2.2.8	Replacing the MicroSD Card	36
2.2.9	Tools Required for Installation	36
2.2.10	Preparatory Steps	37
2.3	Installing the S26 Flex	38
2.3.1	Connecting Network Cables and Additional S26 Cables	38
2.3.2	Attaching the S26 Camera Housing	38
2.4	Network and Power Connection, Additional Cables	40
2.4.1	Network Cabling for S26 with Patch Cables	40
2.4.2	Network Cabling for S26 with Installation Cables	41
2.4.3	Connecting Additional Cables	43
2.4.4	Power Supply Using a Switch	44
2.4.5	Power Supply When Connected Directly to a Computer	45
2.4.6	Power Supply with Power-Over-Ethernet Products	45
2.4.7	Variable PoE	46
3	Operating the Camera	48
3.1	Manual and Automatic Operation	48
3.2	First Images and the Most Important Settings	50
3.2.1	Manually Setting Up the Network Parameters in a Browser	50
3.2.2	First Images and the Most Important Settings in the Browser	53
3.2.3	First Images and Network Parameter Configuration in MxMC	55
3.2.4	Start Options of the Camera	58
3.3	Virtual PTZ and Full Image Recording	60
3.3.1	Preparing the Virtual PTZ Function	60
3.3.2	Full Image Recording	62
3.3.3	Special Configuration in the Browser	64

Table of Contents

3.4	MicroSD Card Recording	71
3.4.1	Introduction	71
3.4.2	Formatting the MicroSD Card	73
3.4.3	Activating Recording	74
3.4.4	Accessing Data on the MicroSD Card	75
3.4.5	Deactivating Card Recording	75
3.4.6	Using a MicroSD Card in a Different MOBOTIX Camera	76
3.4.7	Limitations on Warranty When Using Flash Storage Media	76
3.5	Configuration in the Browser	77
3.5.1	Overview	77
3.5.2	General Browser Settings	79
3.6	Setting Up an S26 Flex as Door Station	81
3.6.1	Installation	81
3.6.2	Executing the Auto Configuration	82
3.7	Additional Notes	83
3.7.1	Reduced Weather Protection When Installing Upside-Down	83
3.7.2	Password for the Admin Menu	84
3.7.3	Permanently Deactivating the Microphone	84
3.7.4	Using the Start Options of the Camera	84
3.8	Activating Event Control and Motion Detection	85
3.8.1	Deactivating Text and Logo Options	85
3.8.2	Deactivating the Camera Reboot	85
3.8.3	Browser	85
3.8.4	Cleaning the Camera and Lens	86
3.8.5	Online Help and Camera Information in the Browser	86
3.8.6	Declaration of Conformity	86
3.8.7	RoHS Declaration	86
3.8.8	Disposal	87
3.8.9	Disclaimer	87

SAFETY WARNINGS



Notes on Installing:

- This product must not be used in locations exposed to the dangers of explosion.
- Make sure that you install this product as outlined in Chapter 2, «Installation» of this manual. A faulty installation can damage the camera!
- When installing this product, make sure that you are only using genuine MOBOTIX parts and MOBOTIX connection cables.
- Only install this product on suitable, solid materials that provide for a sturdy installation of the fixing elements used.



Electrical installation: Electrical systems and equipment may only be installed, modified and maintained by a qualified electrician or under the direction and supervision of a qualified electrician in accordance with the applicable electrical guidelines. Make sure to properly set up all electrical connections.



Electrical surges: MOBOTIX cameras are protected against the effects of small electrical surges by numerous measures. These measures, however, cannot prevent the camera from being damaged when stronger electrical surges occur. Special care should be taken when installing the camera outside of buildings to ensure proper protection against **lightning**, since this also protects the building and the whole network infrastructure.



Max. power consumption of attached extension modules: The power consumption of all attached must . When attaching modules to the MxBus connector the USB socket, the , . If is used, **Never touch the lens:** Due to the high performance of the S26, the area of the image sensor **can get quite hot**, especially when the ambient temperature is also high. This does not affect the proper functioning of the camera in any way. For this reason, the product must not be installed within the reach of persons.



Power off before opening the camera: Make sure the power supply to the camera is disconnected before opening the camera housing (e.g., when inserting or exchanging lenses, lens units and SD cards).

LEGAL NOTES

Legal aspects of video and sound recording

You must comply with all data protection regulations for video and sound monitoring when using MOBOTIX products. Depending on national laws and the installation location of the S26, the recording of video and sound data may be subject to special documentation or it may be prohibited. All users of MOBOTIX products are therefore required to familiarize themselves with all applicable regulations and to comply with these laws. MOBOTIX AG is not liable for any illegal use of its products.



NOTES ON SYSTEM SECURITY (“CYBER SECURITY”)

To protect the camera against security risks in data technology, the following measures are recommended after the installation has been completed:



- **MxManagementCenter:**
 - Menu :
 - :√
 - :√
 - :√
 - (for all users):
 - :√
 - : After 5 min
- **User interface of the camera in the browser:**
 - :
 - : -
 - :√
 - : 10
 - : 60 Minutes
 - :√

For more information on this topic, please read the «Cyber Protection Guide» on www.mobotix.com (under **Support > Download Center > Documentation > Brochures & Guides > Cyber Security**).

FOREWORD

Dear MOBOTIX customer,

Congratulations on your decision to purchase a professional and modern HiRes network camera “Made in Germany”! The robust and versatile S26 has a hemispheric sensor module (day or night) that is integrated into the camera housing. This camera can be placed discreetly and securely behind walls and ceilings or stainless steel panels (using the AudioMount, for example). If a speaker is required, why not use the SpeakerMount for easy installation into ceilings or walls?



The weatherproof MxBus and MiniUSB interfaces of the camera allow attaching MOBOTIX interface boxes and standard devices, such as 3G/UMTS modems, external storage devices, etc. The pre-installed MicroSD card flash storage is easily exchanged for larger storage requirements, providing for secure long-term storage.

The introduction of the newest image sensor technology with increased light sensitivity provides brilliant images with image sizes of up to 3072x2048 pixels, thus delivering color images of higher quality under lowlight conditions.

You can download the **MxManagementCenter** video management software for MOBOTIX cameras from the MOBOTIX website: www.mobotix.com > **Support** > **Download Center** > **Software Downloads**. The tutorial for the application is available from **Support** > **Download Center** > **Documentation** > **Brochures & Guides** > **Tutorials**.

For iPad, iPhone, and Android devices, MOBOTIX offers the **MOBOTIX MxBell**, a free-of-charge mobile solution that is easily found when searching for “MOBOTIX AG” in the App Store or on Google Play.

If you have any questions, our support and international sales staff are available at intl-support@mobotix.com from Monday to Friday, 8 am to 6 pm (German time).

We would like to thank you for your trust and wish you all the best with your new MOBOTIX camera S26 Flex!

MOBOTIX

BeyondHumanVision

BeyondHumanVision

MOBOTIX



S26 – camera with one hemispheric image sensor
for concealed installation behind walls or over ceilings



1 PRODUCT OVERVIEW

1.1 S26 – Lenses, Hardware, Image Formats

Lenses, Sensors	
B016 Hemispheric	•
B036 Superweitwinkel	–
B041 Superweitwinkel	–
B061 Weitwinkel	–
B079 Standard	–
B119 Tele	–
B237 Tele	–
B500 Tele	–
CSVario 4.5 bis 10 mm	–
Image sensor with custom exposure zones	Color/BW
Sensor sensitivity 6MP in lux at 1/60 s and 1 s	0,1 / 0.005 (Color) 0,02 / 0.001 (BW)
Hardware Features	
IP protection class	IP66
Temp. Internal DVR (MB)	64
Internal DVR (MicroSD, SDXC, pre-installed)	•
Microphone/speaker	–/–
Passive infrared sensor (PIR)	– (via MxMultiSense MxBus module)
Integrated temperature sensor	•
Shock detector	•
Power consumption in Watts (typical)	< 5 W
Variable PoE class	2 – 3
Image Formats, Frame Rates and Image Storage	
Max. resolution	6MP (3072x2048)
Max. frame rate (MxPEG, max. resolution)	6MP : 12 fps
CIF images with 4 GB MicroSD DVR	250,000
VGA images with 4 GB MicroSD DVR	125,000
MEGA images with 4 GB MicroSD DVR	40,000
QXGA images with 4 GB MicroSD DVR	20,000

1.2 S26 – Software Features

General Features	
Digital zoom (continuous) with panning	•
Motion JPEG/MxPEG codecs	•/•/•
Programmable exposure zones	•
Snapshot rec. (pre-/post-alarm images)	50
Terabyte ring buffer storage (internal/network)	•
Event/continuous rec. with sound (0.2 to 30 fps)	•/•
Time and event control	•
Weekly schedules/holidays	•
Web functionality (FTP, email)	•
Playback/Quad and MultiView, bidirectional sound in browser	•
Logo generator, animated	•
Flexible event logic	•
Master/Slave arming	•
Several scheduled privacy zones	•
Customized voice messages	•
VoIP telephony (audio/video, alert)	•
Remote alarm notification (network msg.)	•
Signal inputs/outputs, RS232	Via MX-Input-Box/MX-Output-Box or MX-232-IO-Box
Programming interface/HTTP API	•
Security features (HTTPS/SSL, IP-based access control, IEEE 802.1X network authentication)	•
Video Analysis	
Video Motion detector	•
MxAnalytics	•
MxActivitySensor	•
Video Management Software	
MxManagementCenter	•
MOBOTIX MxBell	•

Free-of-charge download from www.mobotix.com or App Store/Google Play

1.3 S26 – Technical Data

Model Variants	Mx-S26A/B*-6D016 (daylight image sensor, color) Mx-S26A/B*-6N016 (night image sensor, Black&White) *Variant Mx-S26B supports MOBOTIX MxBus modules
Lens Option	B016 (focal length 1.6 mm, f/2.0, image angle 180°x180°)
Sensitivity	Color sensor (daylight): 0,1 lx @ 1/60s; 0,005 lx @ 1s Black&White sensor (night): 0,02 lx @ 1/60s; 0,001 lx @ 1s
Image Sensor	1/1.8" CMOS, 6MP (3072x2048), Progressive Scan
Max. Image Size	6MP (3072x2048)
Image Formats	Freely configurable 4:3, 8:3, 16:9 or custom formats (image cropping), e.g., 2592x1944 (5MP), 2048x1536 (QXGA), 1920x1080 (Full-HD), 1280x960 (MEGA)
Max. Frame Rate	MxPEG: 42@HD(1280x720), 34@Full-HD, 24@QXGA, 15@5Mp, 12@6MP M-JPEG: 26@HD(1280x720), 13@Full-HD, 9@QXGA, 5@5Mp, 4@6MP H.264: 25@Full-HD, 20@QXGA
Video Codec	MxPEG, M-JPEG, JPEG (max. output size 6MP) H.264 (max. output size QXGA, bandwidth limitation applicable)
ONVIF	ONVIF-S (camera software V5.2.x and higher)
DVR	In the camera on MicroSD card (SDXC, SDHC pre-installed) <ul style="list-style-type: none"> • External, on USB device • External, on NAS • Separate live image and full image recording – MxFFS with archiving function • Pre- and post-alarm images • Automatic DVR monitoring with error notification
External Video Ring Buffer	Directly on NAS and computer/server without additional recording software
Software	MxManagementCenter, MOBOTIX MxBell
Image Processing	MxLEO, backlight compensation, automatic white balance, distortion correction
PTZ	Digital pan/tilt/zoom, continuous up to 8X
Alarm/Events	Temperature sensor, shock detector (with firmware version 5.0.1 and higher), microphone, additional sensors/IOs via MxMessageSystem, notification via e-mail, FTP, IP telephony (VoIP, SIP), visual/sound alarms, pre- and post-alarm images
Intelligent Video Analysis	MxActivitySensor, video motion analysis, MxAnalytics
Audio	External microphone and speaker can be connected 16 bit/16 kHz (HD wideband audio) ip-synchronous audio, audio recording VoIP/SIP telephony, intercom, remote controlling using key codes
Interfaces	10/100 Ethernet (patch or installation cable), MiniUSB, MxBus*; inputs/outputs and RS232 via accessories; external microphone, external speaker *Only variant Mx-S26B

Security	User/group management, HTTPS/SSL, IP address filter, IEEE 802.1x, intrusion detection, digital image signature, MxFFS
Certifications	EN 55032:2012, EN 55024:2010, EN 50121-4:2015, FprEN 61000-6-1:2015, EN 61000-6-2:2015, EN 61000-6-3:2007+A1:2011+AC:2012, EN 61000-6-4:2007+A1:2011, EN 50581:2012, EN 60950-1:2006+A11:2009+A1:2010+A12:2011+A2:2013, E13*10R05/01*14649*00, 47 CFR Part 15B, AS/NZS CISPR32:2015
Power Supply	Power over Ethernet IEEE 802.3af
Power Consumption	Typ. 5W
Power Consumption of External Devices	At MxBus: max. 3W, at USB: max. 2.5W, total max. 4W The power consumption of the camera will increase accordingly!
Protection Classes	IP66 IK07
Ambient Temperature	-40 to 60 °C/-40 to 140 °F
Dimensions/Weight	W x H x D: 115 x 130 x 48 mm; Weight: approx. 430g/0.948 lb
Standard Delivery	Housing (high-resistance composite, PBT) white, mounting supplies, mounting wrenches, 50 cm/20 in patch cable, software, MicroSD card (SDXC, SDHC installed)



1.4 S26 – Delivered Parts and Dimensions

1.4.1 The S26 Camera



S26 – Delivered Parts and Dimensions

Item	Number	Part Name
1.1	1	Camera housing (with base plate)
1.2	1	Lens L10 (6MP)/L12 (5MP) (installed)
1.3	1	Dome (installed)
1.4	1	Housing cover for S15M (installed)
1.5	3	Stainless steel flat-head Allen screw M4x8 (installed)
1.6	1	Washer
1.7	1	Sealing plug, blue, small (sensor modules, USB, inserted)
1.8	1	Sealing plug, blue, large (Ethernet patch cable, installed)
1.9	1	Cable retainer with bayonet catch (Ethernet patch cable, installed)
1.10	1	Single wire plug, white (Ethernet installation cable, microphone, speaker, MxBus)
1.11	1	MicroSD card pre-installed (SDXC)
1.12	1	Rotary plug, SD card, blue (installed)
1.13	1	Ethernet patch cable, 50 cm, with seal

Mounting Supplies

Item	Number	Part Name
M.1	4	Stainless steel washers, diam. 4.3 mm
M.2	4	6-mm screw anchors
M.3	4	Stainless steel wood screws 4x40 mm with PZ 2 driver bit
M.4	2	Cable plug, 5-7 mm, white (Ethernet installation cable)
M.5	1	Cable plug, 3-5 mm, white (Ethernet installation cable)
M.6	1	Allen wrench 2.5 mm
M.7	1	Lens wrench (lens, dome)
M.9	1	Cable tie (Ethernet installation cable, microphone, speaker, MxBus)
M.10	1	Screwdriver (screw clamps)

S26 Camera Housing

The MOBOTIX S26 consists of a base plate for attaching the camera, a housing with built-in lens, and a housing cover.

LED default settings:

- 1 Power (on), Error (flashing)
- 2 Recording (flashing)

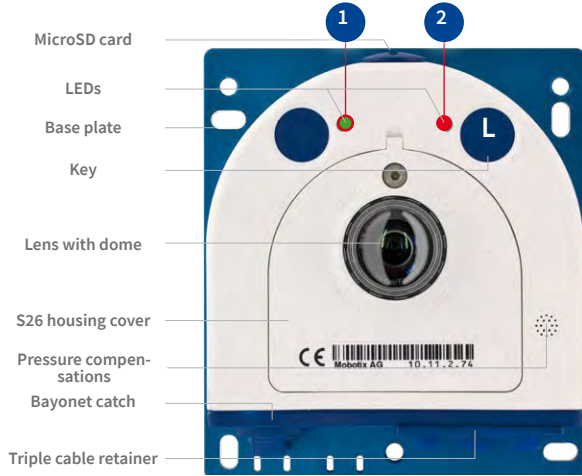

Externally Accessible Connections of the S26

The MOBOTIX S26 provides the following external connections that can be accessed once the cover plugs are removed:



Cables with straight plugs can be used for the S26 on the camera only

The external connections may only be used with the designated sealed MOBOTIX cables (MX-OPT-CBL-LAN-1/2/5/10 Ethernet patch cable and MX-MX-CBL_MU_STR-5 MiniUSB cable).

Internally Accessible Connections of the S26

The MOBOTIX S26 provides the following internal connections that can be accessed once the cover plugs and housing cover are removed:

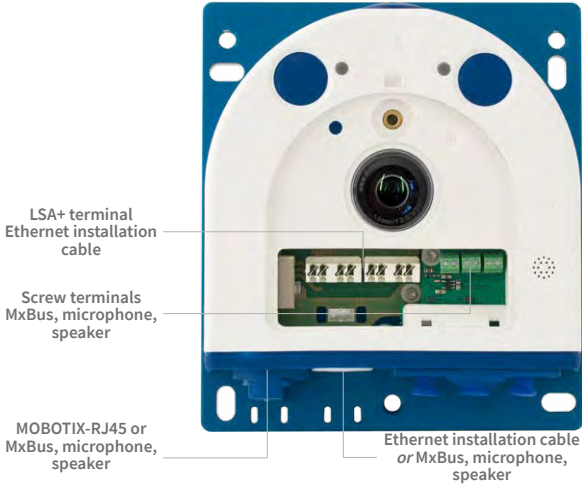

Before installing the Ethernet installation cable, remove the bayonet catch and replace the Ethernet patch cable plug with either one of the additional plugs (M.4/5) or the single wire plug (1.10), depending on the cable used.

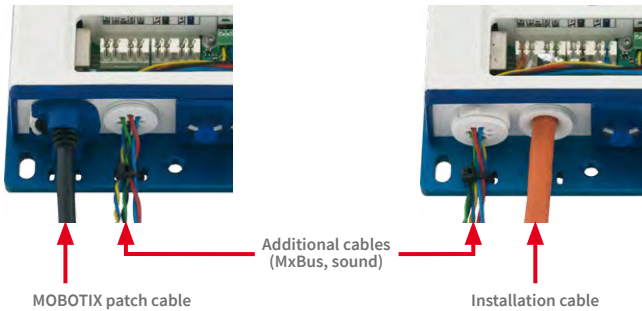

The drilling templates are available from www.mobotix.com, Support > Download Center > Documentation > Drilling Templates

Always print or copy drilling template in their original size!

Dimensions S26

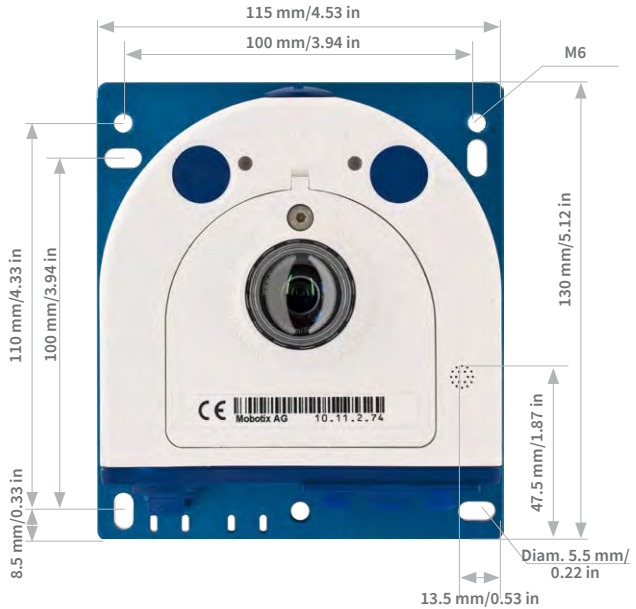



Attaching the Camera Housing

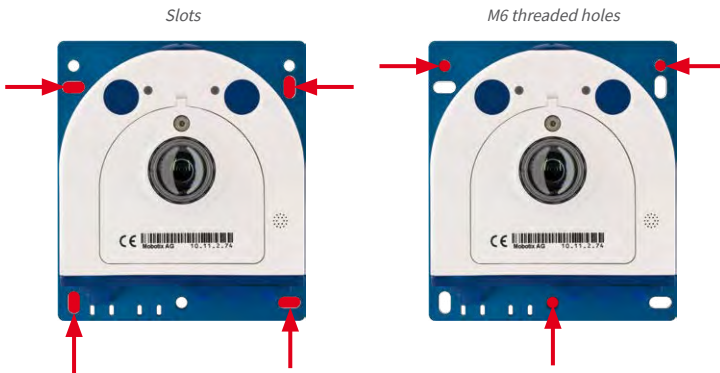

Cables with straight plugs can be used for the S26 on the camera only

1.5 Available Accessories

1.5.1 MiniUSB Cable to MiniUSB (Straight/Straight or Straight/Angled)

Order No.: MX-CBL-MU-STR-05/2/5 (Straight/Straight)
Order No.: MX-CBL-MU-EN-STR-05/2/5 (Straight/Angled)

With this cable, which is up to five meters long, MOBOTIX add-on modules (MX-232-IO-Box, ExtIO, CamIO) can be connected directly to the S26.



1.5.2 MiniUSB Cable to USB a Socket

Order No.: MX-CBL-MU-STR-AB-05/2/5

USB-based storage media (for example, USB hard drives) can be connected directly to the S26 with this cable, which is up to five meters long.



1.5.3 Ethernet Patch Cable for Bayonet Catch

Order No.: MX-OPT-CBL-LAN-1/2/5/10
(length 1 m/2 m/5 m/10 m)

The MOBOTIX-developed special cable can be installed in a waterproof manner and has an integrated sealing gasket. Every S26 ships with a 0.5-m-long cable as standard, which can be exchanged for a patch cable up to 10 m in length.



1.5.4 NPA-PoE-Set

Order No.: MX-NPA-PoE-EU u. MX-NPA-PoE-INT (Version EU and Version INT)
Order No.: MX-CBL-NPA-BAT-2 (battery cable for mobile voltage sources)

This is a multifunctional PoE injector according to the IEEE 802.3af standard – with three connectors (for network, camera/PoE device, PC), universal power supply unit with interchangeable adapter plugs and crossover function. The NPA-PoE-Set connects and remotely supplies an S26 with power via an Ethernet cable up to 100 m in length. The blue adapter can also be connected to mobile voltage sources from 12 to 42 V DC by means of an additionally available battery cable. The “EU” version of the NPA-PoE-Set is supplied as standard with a European adapter, while the “INT” version includes four adapters (EU, USA, UK, AUS).



1.5.5 MX-Overvoltage-Protection-Box

Order no.: MX-Overvoltage-Protection-Box-RJ45

Order no.: MX-Overvoltage-Protection-Box-LSA

Weatherproof network connector (protection class IP65, -30 to 60°C/-22 to 140°F) **with surge protection of up to 4 kV for MOBOTIX IP cameras**, ideal for replacing the MX-Patch-Box. At the same time, the MX-Overvoltage-Protection-Box provides a weatherproof connection of a camera's patch cable to a network patch cable (-**RJ45** variant) or a network installation cable (-**LSA** variant).



1.5.6 MX-NPA-Box

Order No.: MX-OPT-NPA1-EXT

The MX-NPA-Box is a weatherproof PoE injector conforming to the IEEE 802.3af standard and is designed to connect to a MOBOTIX camera external voltage sources (12 to 57 V DC).

The MX-NPA-Box is equipped with the weatherproof and extremely compact exterior housing of the Patch-Box (protection class IP66, -30 to +60°C/-22 to +140°F, which means it can also be installed in the space of the Outdoor Wall Mount. MX-NPA-Box interfaces: Camera via patch cable, Ethernet via LSA+ and external power supply (12 to 57 V DC is possible).



1.5.7 MX-GPS-Box

Order No.: MX-OPT-GPS1-EXT

This box primarily serves as a high-precision time source for systems without an Internet connection. The IT and Secure models additionally provide triggering of GPS-based events (reaching or moving away from a specified position; exceeding or not reaching a specified speed). The MX-GPS-Box can be connected as an add-on module to all MOBOTIX cameras with an MxBus interface.

The MX-GPS-Box has the same compact exterior housing as the MX-Patch-Box and the MX-NPA-Box (IP66 protection class, -30 to +60°C/-22 to +120°F). Note that this box should not be installed below other wall-mounted units. It should be installed on the exterior of the building with a large section of open sky above it, which ensures the best possible reception from GPS satellites and thereby the highest possible accuracy of the received GPS data. The maximum length of the MxBus cable (diameter: 0.8 mm) is 50 m.



1.5.8 MX-232-IO-Box

Order No.: MX-OPT-RS1-EXT

This box provides the signal inputs and outputs as well as the RS232 (serial) interface. It replaces the connections that were handled on the older camera models via a D-Sub 15-HD connector. The MX-232-IO-Box can be connected as an add-on module to all MOBOTIX cameras with an MxBus or USB interface. The maximum length of the MxBus cable (diameter: 0.8 mm) is 50 m. If the MiniUSB connection is used, the maximum cable length is 5 m.



1.5.9 ExtIO Expansion Module

Order No.: MX-ExtIO

The device, which is suitable both for on-wall and in-wall installations, contains a powerful speaker, microphone, infrared motion sensor, ambient temperature sensor, two input and two output contacts and two illuminated keys. It is ideal for door communication, elevators, access control systems, etc. The ExtIO is suitable for use as direct connection to the S26 via a MiniUSB cable (max. 5 m), which can be ordered separately, or as a network connection via the PoE switch.



1.5.10 Mx2wire+ Media Converter

Order No.: MX-2wirePlus-Set-PW

The Mx2wire+ system allows an Ethernet network with PoE to be set up via two-wire cables, which saves users from having to lay several hundred meters of Ethernet cable. For example, an existing two-wire cable of an analog video camera can be reused to connect a high-resolution and modern IP network camera. Mx2wire+ is delivered in the standard wall outlet frame in different designs; however, it can also be used with the available on-wall socket that is included.



Available Accessories

1.5.11 AudioMount

Order no.: Mx-S26A/B

The AudioMount is an installation option for the S26 with a self-adhesive front that can be attached to the back of thin and smooth surfaces (stainless steel plate, mailbox, etc.). The AudioMount has a pre-installed speaker and microphone, thus ensuring full intercom capabilities of the camera. Together with the AudioMount and additional MOBOTIX accessories, you can easily set up the S26 Flex as a hemispherical door station (note that the camera needs to run a firmware 4.1.9 or higher).



1.5.12 SpeakerMount

Order no.: MX-HALO-SP-PW/CM









The SpeakerMount, available from MOBOTIX in white or matt chrome, is an external speaker that can be directly connected to the S26/S26 (no additional power supply required). The high-quality speaker is especially suitable for S26 cameras. The speaker is pre-installed in the 20-degree-tilting mechanism of the HaloMount and is fitted in the same way in fake ceilings and walls. The SpeakerMount has not been designed to be used in outdoor applications. Temperature range: 0 to +60°C/32 to 140°F; protection class: IP20; nominal/music output: 3/4 W; impedance: 8 Ohms; material of the speaker: metal with perforated steel cover; connection type: two-wire strand with luster terminal; installation diameter: 68 mm/2.7 in.



1.5.13 Other Accessories

Since the range of accessories for the MOBOTIX system keeps growing, you will find the list of applicable accessories in the **Camera Configurator** on the MOBOTIX website www.mobotix.com.

THE MOBOTIX INFORMATION CHANNELS

 BeyondHumanVision	Support on the MOBOTIX Website www.mobotix.com/en/support	
	The MOBOTIX Video Tutorials www.mobotix.com/en/support/download-center/documentation/video-tutorials	
	Seminars on MOBOTIX Campus www.mobotix.com/en/support/trainings	
	The MOBOTIX YouTube Channel www.youtube.com/user/MobotixAG	

1.6 MOBOTIX Software

1.6.1 Integrated Camera Software (Firmware)

MOBOTIX cameras and connected MxBus modules operate with built-in firmware whose functions are accessed by the MOBOTIX MxManagementCenter remote stations and MOBOTIX MxBell.

The S26 models therefore also feature a variety of functions that are integrated in the firmware: from motion detection and long-term storage right through to alarm notification via video IP telephony. The virtual PTZ functions allow you to continuously zoom into or out of a MOBOTIX camera image using either the mouse wheel or a joystick.

When recording image or video sequences, you can choose to store either the section of the live image that is visible or the full sensor image (full image storage). This also allows you to examine parts of an image or video that had not been visible in the live image section on display at the time of the recording.

Unlike in the camera systems from other manufacturers, there is no need to buy and install additional software on your computer thanks to the MOBOTIX firmware that can be accessed directly in a web browser via the camera IP address. Instead of using a web browser, you can also download the free MxManagementCenter video management software from the MOBOTIX website (www.mobotix.com > Support > Download Center > Software-Downloads) to quickly display multiple cameras on one monitor or on an entire video wall, switch alarms with sound or conveniently search for an event. The MOBOTIX MxBell for iOS and Android devices (iOS 11/Android 5.0 and higher) is also available free of charge from the **App Store/Google Play** for your mobile applications.

Download free of charge
from www.mobotix.com

No license fees!
Free updates!

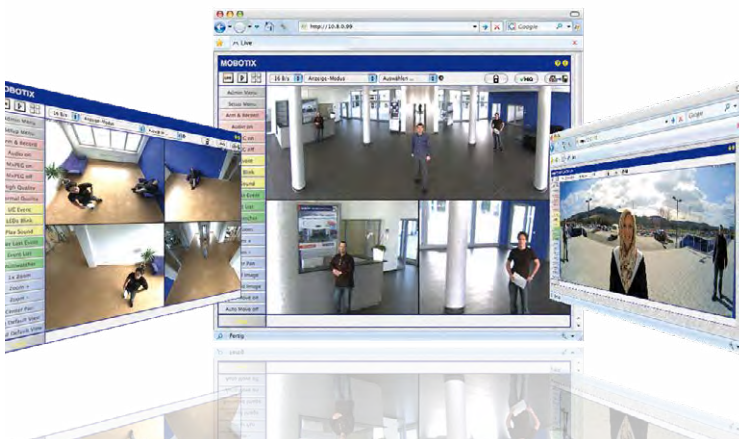



1.6.2 MxManagementCenter

MxManagementCenter (MxMC) is a completely new development that focuses on a unique and intuitive user experience. Single and double click, drag&drop, support of several screens and direct view of events and alarm messages are just some of the many advantages of the new software.

MxManagementCenter is perfectly designed in combination with MOBOTIX cameras representing the decentralized concept at its best. MxMC allows controlled recording access via the camera or later directly to the NAS.

A unique feature is the adaptive bandwidth management supporting quality search even over mobile networks with very limited bandwidth. MxMC is 100% free of charge, requiring no license or update costs and at the same time having no limits in terms of users, screens and cameras.

MxManagementCenter – simple operation of the most important camera functions:

- Integration of an unlimited number of cameras
- Camera groups with representation in Grid and Graphic views, Grid views with a focus window and many controls
- Optical and audible alarming of new events
- Instant Player that allows for quick viewing of the latest events during live video monitoring operation
- Easy use of multiple monitors by double-clicking on the live image, grid or event image
- Door station functions (intercom, open door, turn light on/off, etc.)
- Subsequent distortion correction of hemispheric camera images - in live images and in recordings

Download free of charge
from www.mobotix.com

No license fees!
Free updates!



1.6.3 MOBOTIX MxBell

Never miss another visitor, thanks to push notifications! Use MOBOTIX MxBell on your smartphone or tablet to receive notifications from the doorbell of a MOBOTIX IP Video Door Station and live views from MOBOTIX cameras. This app helps you open the door and enables hands-free talking, automatic camera search, a live view, camera connection via SSL and display of the connection status.



Our new MOBOTIX MxBell is here!

The update scores with its new playback function, which makes it possible to search through the recorded events for the integrated Door Stations and cameras at a specific time point and play back the individual clips. In addition, the Grid view will simultaneously display up to four cameras, which in particular is a great advantage for small installations.

- Never miss another visitor, thanks to push notifications.
- Displays doorbell messages from MOBOTIX IP Video Door Stations.
- Live views from MOBOTIX IP cameras with gesture-controlled PTZ function.
- Open the door from anywhere, hands-free talking.
- Automatic camera search, live view and camera connection using SSL.
- Displays the connection status.
- Supports remote connections and mobile data.
- iOS 11/Android 5.0 and higher



Free download from [App Store](#)/[Google Play](#)

No license fees!
Free updates!

2 INSTALLATION

Like all MOBOTIX cameras, the S26 is **extremely flexible** in terms of how and where it can be installed. An S26 can be used for both indoor and outdoor applications. In fixed or mobile applications – constantly changing locations or in/on vehicles of any kind. The S26 cameras are **weatherproof according to IP66** and can work reliably in temperatures ranging from –40 to 60 °C / –40 to 140 °F without extra housing, heating or fan.

Thanks to the concealed installation, you can easily add **MOBOTIX interface boxes** next to the camera.

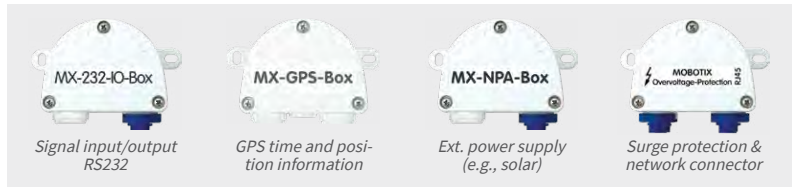

Please Remember These Basic Rules When Installing

1. Unused connectors on the housing of the S26 must always be sealed using the plugs installed as standard on delivery as well as the corresponding retainers.
2. Only original MOBOTIX cables should be used to connect the sensor modules, patch cables and USB cables in order to guarantee weather resistance according to IP66. The plugs supplied must be used if additional cables are required (MxBus, audio).
3. The lower (blue) part of the camera housing must face downwards so that any water running off the housing cannot accumulate around the connectors.

2.1 Preparing the Installation

The following questions should be answered before mounting the MOBOTIX S26:

1. Where and how will the camera be mounted?
2. What accessories might be needed?
3. How is the camera connected to the network and how is the power supplied?
4. How are the connections furnished from the building?
5. What cabling considerations are necessary?

The following sections contain answers to each of these questions. If you have more detailed questions, please ask your MOBOTIX partner directly or contact the MOBOTIX support. To find the contact data, please open www.mobotix.com and the **Support** section.

The S26 has just one lens, which does not have a flexible sensor cable, but is directly connected to the camera housing. Contrary to conventional single-lens cameras, the S26 has come up with a very neat trick:

The camera housing can be mounted concealed behind a wall up to 6.4 mm/0.25 in thick (wood paneling, stainless steel panel, etc.) with a round opening measuring 34 mm/1.34 in. The S26 can simply be fixed behind the wall and leave only the lens visible.

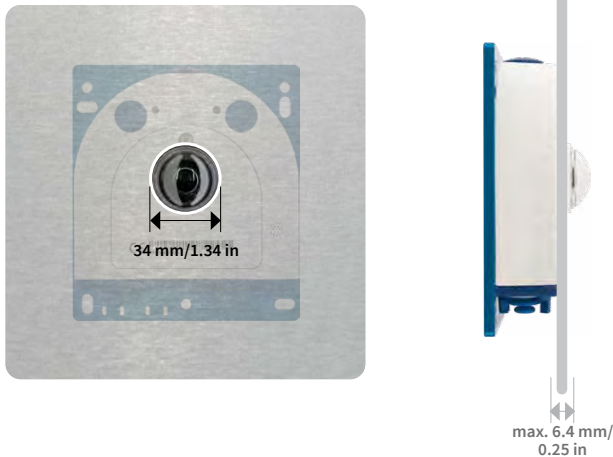

This results in the following installation options:

- Wall- and ceiling-mounting behind correspondingly thin or countersunk panels/cover plates.
- Individual mounting solutions such as installation in industrial equipment, paneling, air ducts, mail boxes, homemade mounts, etc.

Open www.mobotix.com, go to **Products Outdoor Cameras > S26 Flex** to view and order further accessories for the MOBOTIX S26 system

Note on AudioMount

This installation frame with self-adhesive rear side allows quick mounting of the S26 behind stainless steel panels or similar materials. The mount includes pre-installed microphone and speaker.

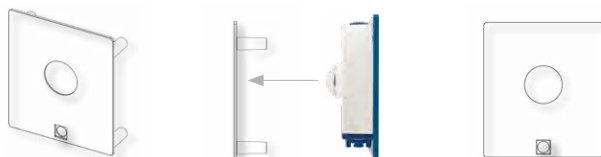

2.2 Before Mounting

This section of the manual provides an overview of the variety of S26 connection options, the preparatory steps and the tools required for mounting.

2.2.1 Overview of Cable Connections

The following cables can be used with the S26 (see also Section 1.5, «Available Accessories»):

- **MOBOTIX patch cable:** This supplied MOBOTIX cable is designed for direct connection to the **MX-Patch-Box**, the **MX-NPA-Box** or a standard network port (only in indoor areas).
- **Ethernet installation cable:** As an alternative to the **MOBOTIX patch cable** (see above) an Ethernet installation cable can also be fitted directly onto the integrated LSA cutting clamp.
- **MOBOTIX USB cable with MiniUSB connector:** This MOBOTIX cable provides the required impermeability, even in adverse weather conditions, and thereby prevents corrosion of the connectors, for example, on an external USB hard drive.
- **Additional cable for MxBus connections, microphone and speaker:** Additional MOBOTIX modules can be connected via this multi-wire cable. The other camera opening is used for this cable or for single wires, depending on which connection is used for network cabling (patch or installation cable).

Before Mounting

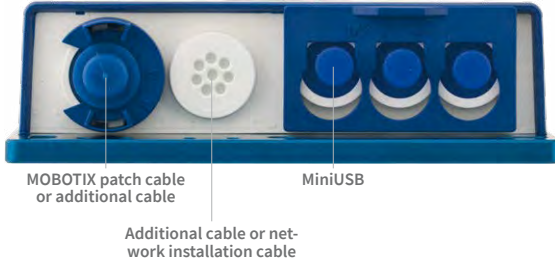

Caution

Only **MOBOTIX cables** may be used for the **Ethernet and USB connection** as well as **to the sensor modules (S26)** to ensure the camera remains permanently watertight.



Unused connections must be secured using appropriate cable plugs and by closing the corresponding locks to protect the inside of the housing against water and dust.



Connectors pointing down

Avoid Installing Upside-Down (Reduced Weather Protection)



If you are installing the S26 upside-down (i.e., the connectors are pointing upwards), the camera does not reach protection class IP66 any more, but only IP54. If mounted upside-down, the S26 can only be used in a dry indoor environment.



Connectors pointing up



Removing MOBOTIX Cables and Plugs

The corresponding lock must first be removed or released to remove one of the cables or plugs indicated above from the S26:

Patch Cable	MiniUSB Sensor Cable
	
<ol style="list-style-type: none">1. Turn the bayonet catch to the left.2. Remove the bayonet catch.3. Remove the cable/plug.	<ol style="list-style-type: none">1. Pull the triple retainer upwards (away from the base plate) until it clicks into place.2. Remove the cable/plug.

Inserting and Locking MOBOTIX Cables and Plugs

The corresponding lock must be applied or closed again after inserting one of the cables or plugs indicated above into the S26:

Patch Cable	MiniUSB Sensor Cable
	
<ol style="list-style-type: none">1. Insert the cable/plug.2. Attach bayonet catch.3. Turn the bayonet catch to the right.	<ol style="list-style-type: none">1. Insert the cable/plug.2. Push the triple retainer down (towards the base plate) until it clicks into place.

2.2.2 Notes on Cable Lengths and Power Supply

- Power is supplied to the camera via the camera Ethernet connection (patch or installation cable). We recommend using a MOBOTIX PoE adapter or another similar high-quality PoE product to loop-in the power supply:
 - **One camera:** with the PoE adapter (MX-NPA-PoE or MX-NPA-Box)
 - **Multiple cameras:** with PoE products conforming to IEEE 802.3af (PoE switch)
- The **maximum length** of the network cable for power supply over an Ethernet cable is **100 m/110 yd**.
- Make sure that you only use switches or routers that support the **10/100 Mbps network interface** of the camera.

Before Mounting

- We highly recommend using uninterruptible power supplies (UPS) to provide backup power.
- If you are using IEEE 802.3af or IEEE 802.3at (PoE+) Power-over-Ethernet network components to supply power to MOBOTIX cameras, make sure, if possible, that these components do not have a fan. Since the power consumption of MOBOTIX cameras is very low compared to other products, the reliability of the entire system is increased, thus extending the life of these components.

Caution

Max. power consumption of attached extension modules: The power consumption of all attached **MxBus modules** must **not exceed 3 W**. When attaching modules to the MxBus connector **and** the USB socket, the **power consumption of all attached modules must not exceed 4 W, if the camera is powered by PoE class 3**. If **PoE class 2** is used, **the camera cannot power any peripheral devices!**

For more information on changing the PoE class, please see Section 2.4.7, «Variable PoE».

2.2.3 Network Connection with MOBOTIX Patch Cable

The supplied **MOBOTIX patch cable** can be used to connect the camera to an **MX-Patch-Box**, an **MX-NPA-Box** or to a standard network port.

Connecting the Patch Cable to the Camera

First remove the blue bayonet catch and the blue sealing plug in the left-hand connector on the S26. Then insert the MOBOTIX patch cable into the camera and secure the cable using the bayonet catch.

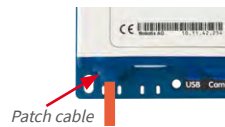

Connecting the Patch Cable to an MX-Patch-Box, MX-NPA-Box or Standard Network Port

First remove the blue bayonet catch and the blue sealing plug in the right-hand connector on the box to establish the network connection to an MX-Patch-Box or MX-NPA-Box. Then insert the MOBOTIX patch cable into the box and secure the cable using the bayonet catch.

More information on installing an **MX-Patch-Box** or **MX-NPA-Box** is available at www.mobotix.com under **Support > Download Center > Documentation > User Manuals > Accessories > Interface Boxes**.

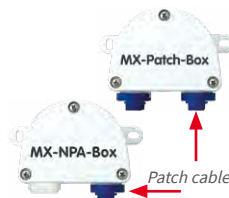

Insert the MOBOTIX patch cable of the S26 into the network port for standard connections (only permitted in indoor areas).

Connecting Peripheral Devices (MxBus, Microphone, Speaker)

The opening provided for the installation cable must be used for all other cables that are connected to the camera when using the MOBOTIX patch cable. Depending on the cable used, the single wire plug installed must be replaced with one of the other cable plugs (M.4/5).

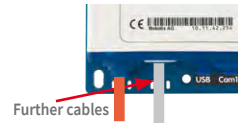

The cable used must be fixed to the circuit board using one of the cable ties supplied (M.9) to ensure that less strain is placed on the cable. The individual cable wires must be fixed on the screw clamps using the the screwdriver supplied (M.9).

2.2.4 Network Connection with Installation Cable

As an alternative to connection to an MX-Patch-Box, MX-NPA-Box or standard network port, you can also connect the S26 directly to an **installation cable**. Since the housing cover of the camera must be opened for this purpose, this working step **in a S26 must be carried out before** mounting the camera as the housing cover is no longer accessible once it has been mounted.

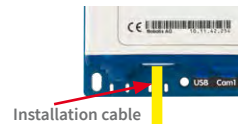

The installation cable is fixed onto the circuit board before fitting the wires onto the LSA cutting clamps using one of the cable ties supplied (M.9) to ensure less strain is placed on the cable and that the camera is earthed correctly.

Connecting Peripheral Devices (MxBus, Microphone, Speaker)

The opening provided for the MOBOTIX patch cable must be used for all other cables that are connected to the camera when using an installation cable. The blue bayonet catch and the blue sealing plug in the left-hand connector must be removed for this purpose. The single wire plug or one of the other cable plugs (M.4/5) is then pushed into the opening, depending on the cable used. The bayonet catch will no longer be used.

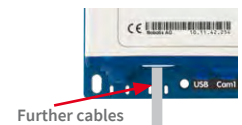

The cable used must be fixed to the **base plate** using one of the cable ties supplied (M.9) to ensure that less strain is placed on the cable. The individual cable wires must be fixed on the screw clamps using the the screwdriver supplied (M.9).

2.2.5 Using the MiniUSB Cable

Existing add-on modules such as the MOBOTIX ExtIO (USB) or external USB hard drives can be connected via the MiniUSB connector. For this purpose, the lock is pulled forward, the left-hand plug is removed and the MiniUSB cable is inserted. The connectors are waterproof again once the lock is pressed down.

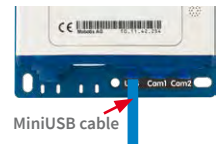

Before Mounting

2.2.6 Using MxBus Modules

The MxBus camera connector is located under the housing cover (clamps 5 and 6 of the screw clamps) and allows the operation of additional modules for expanding functionality (e.g. connection of an MX-GPS-Box for determining time and position). MxBus was optimized specifically for the use of existing two-wire cables.

The terminal connector has two connectors to connect an MxBus module (other MxBus modules can then be connected from there). The length of the entire MxBus cable may not exceed 50 m/55 yd.

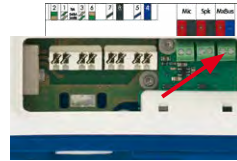

Note

The MxBus wires that are to be stripped at the end should always be fed into the camera through appropriate plugs before mounting. If the single wire plug is used, one wire must be pushed through a hole in the plug.

Do not mix up the polarity of the cables during installation. Select a consistent cable color for +/- in the entire MxBus system (for example, red = +, blue = -)

After an MxBus module has been connected, the MxBus itself must be started in the camera's web-based user interface (if this has not been done yet) as well as the actual module (**Admin Menu > Manage Hardware Expansions or MxBus Modules**).



2.2.7 External Audio Support (Microphone/Speaker)

The camera connector for an external microphone and an external speaker is located under the housing cover (clamps 1 and 2 of the screw clamps for microphone, clamps 3 and 4 for speaker).

An external microphone (red box) and an external speaker (red box) with the following technical data can be connected on the terminal connector:

- **Microphone:** $V_s = 2.0 \text{ V}$, $R_L = 2.2 \text{ k}\Omega$, sensitivity $-35 \pm 4 \text{ dB}$, for example, Panasonic Microphone Capsule WM61
- **Speaker:** Max. power output 400 mW at 8 Ohms impedance, for example, Visaton Speaker K36WP or K50WP

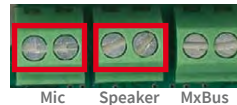
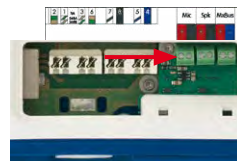

Replace the MicroSD card only if the camera is disconnected from the power supply!

2.2.8 Replacing the MicroSD Card

If the pre-installed MicroSD card needs to be replaced (for example, with a 64 GB MicroSD card), it is best to do so **before** the camera is installed. **MicroSD cards should only be replaced when the camera is disconnected from the power supply.**

1. **Remove rotary plug:** Loosen the rotary plug at the top of the housing, for example, using a suitable coin and remove the plug.
2. **Remove the MicroSD card:** Carefully push the MicroSD card into the holder using a pair of tweezers until you hear a **click**. The card is now sticking out slightly and can be removed using the tweezers.
3. **Insert the MicroSD card:** Push the MicroSD card as shown (electrical contacts pointing towards the front) into the card slot using a pair of tweezers. Make sure that you hear a **click** when the card is inserted. The card is now locked and can be used. **If you are using a new MicroSD card, it needs to be formatted first** (see Section 5.1.2, «Formatting the MicroSD Card»).
4. **Attach the rotary plug:** Insert the rotary plug as shown and screw it tight using a coin (approximately two turns, the plug slot is pointing forwards).

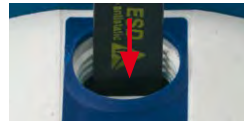

2.2.9 Tools Required for Installation

Please make sure that all the camera components are included in the original packaging (see Section 1.4, «– Delivered Parts and Dimensions»).

Additional Tools/Materials Required

- Any additional materials required for attaching the camera to a ceiling/wall (four wood screws including screw anchors and washers) are included in the original packaging.
- Screwdriver with PZ 2 driver bit.
- Potentially a power drill and 6-mm drill bit for screw anchor holes for attaching the base plate.
- Drilling template for base plate (see www.mobotix.com, Support > Download Center > Documentation > Drilling Templates).
- Scissors to cut out the template.
- Pencil to mark the drill holes.

Before Mounting

- Optionally **LSA+ tool** for fitting an installation cable onto the LSA terminals of the camera.
- **Hole saw** or **Forstner drill** with 44 to 45 mm/1.77 in diameter for the S26 sensor modules or with 35 mm/1.38 in diameter for the S26 lens.
- **Soft cotton cloth** to clean the front of the lens after installation.

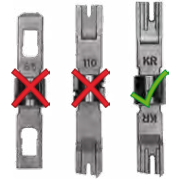

Only use the LSA/
Krone blade and set
to **LOW impact!**

2.2.10 Preparatory Steps

Make sure of the following before starting to install the camera:

- **Connection with MOBOTIX patch cable:** The network connector has been guided either with an MX-Patch-Box, an MX-NPA-Box or a standard network port (only permitted in indoor areas) into the vicinity of the mounting position of the camera.
- **Connection with installation cable:** If a network installation cable is used instead, it may not conduct any voltage and may not be connected to the network.
- **Even surface:** Make sure before attaching the camera that the surface is even so that the base plate of the camera does not move.
- **Pressure vent:** This element on the housing of the S26 and the sensor modules must be kept free to enable pressure equalization of the camera housing..



Do not cover pressure vent

2.3 Installing the S26 Flex

LED default settings:

- 1 Power (on), Error (flashes)
- 2 Recording (flashes)

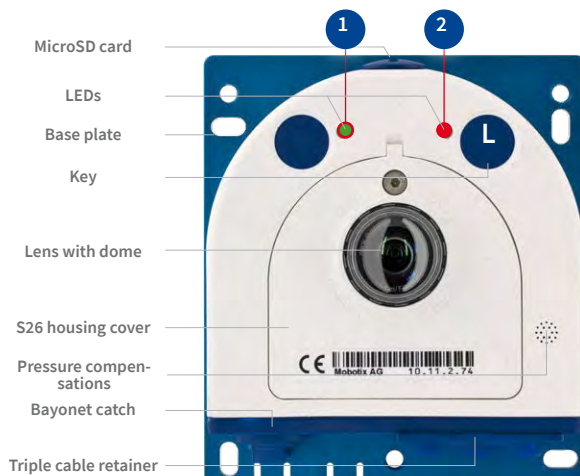

2.3.1 Connecting Network Cables and Additional S26 Cables

As the S26 is mounted in the intended position with the front panel behind, the housing cover cannot be removed after mounting. All the cables to be connected there (Ethernet installation cable, MxBus, microphone, speaker) are then no longer accessible and the connector for the network patch cable can only be accessed with difficulty. The triple lock for connecting the MiniUSB cable can no longer be opened either. This is why you should connect the camera network cables, a MiniUSB cable, if required, and additional cables (MxBus, microphone, speaker) **before mounting the camera** as described in Section 2.4, «Network and Power Connection, Additional Cables».

2.3.2 Attaching the S26 Camera Housing

Use the **drilling template** available from www.mobotix.com, **Support > Download Center > Documentation > Drilling Templates** to mark the position of the drilling holes for the camera. Make sure that it is not scaled down when printing or copying the drilling template.

Caution

Make sure the camera is mounted on an **even surface**. If this is not the case, there is a risk that the housing plate will move and the housing will begin to leak.

The **torque** for the **housing cover screws** is **0.4 Nm**.

Installing the S26 Flex

Attachment to a Rear Wall

If the S26 is attached with the base plate on a rear wall (and then, for example, to a separate stainless steel cover), the camera can be mounted in just a few steps:

1. If necessary, mark the drill holes at the intended mounting position, drill the holes for the base plate and hammer in the **6 mm dowels** supplied.
2. If this has not been done already, insert the cable tie needed to ensure that less strain is placed on the connection cable into the slot provided below in the base plate without closing it.
3. Screw on the S26 with the **4×40 mm screws** included (or other suitable screws) and **washers (with a diam. of 4.3 mm)**.
4. Mark the hole for the camera lens in the cover using the drilling template for the S26 and drill a hole there with a 35 mm/1.38 in diameter.
5. Place the cover over the camera and the cables.



Attachment Behind Screens, Walls or Ceiling Elements

This type of mounting can be completed using various attachment elements.

- Bonded nuts with stud bolts, nuts and washers as shown in the illustration.
- Thicker materials (greater than 6.4 mm/0.25 in) need to be machined accordingly in order to accommodate the camera housing. They can then be attached using anchor nuts or screw sockets as well as stud bolts, nuts and washers or similar.

Make sure that there is enough space behind the mounting surface for the camera and that the pressure vent of the camera is also free after mounting.

1. Mark the hole for the camera lens in the cover using the drilling template for the S26 and drill a hole there with a 35 mm/1.38 in diameter.
2. Mark the places on the mounting surface where the nuts are to be placed with the help of the drilling template.
3. Tighten the stud bolts, nuts and washers.
4. Place the camera from behind onto the prepared attachment elements and screw the camera on tightly (secure nuts with a screw locking device to prevent them from becoming loose).



MOBOTIX offers a mounting kit (accessories) for this type of attachment

2.4 Network and Power Connection, Additional Cables

2.4.1 Network Cabling for S26 with Patch Cables

Using a patch cable and an MX-Patch-Box or MX-NPA-Box offers the following advantages:

- Quick installation/deinstallation
- No shortening of the cable in the event of multiple installation/removal
- Connection that is dust-proof/resistant against water jets in accordance with IP66

Connecting the Patch Cable to the Camera

First remove the blue bayonet catch and the blue sealing plug in the left-hand connector on the S26. Then insert the MOBOTIX patch cable into the camera and secure the cable using the bayonet catch.

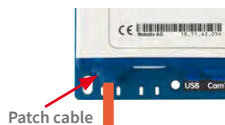

Connecting the Patch Cable to an MX-Patch-Box, MX-NPA-Box or Standard Network Port

First remove the blue bayonet catch and the blue sealing plug in the right-hand connector on the box to establish the network connection to an MX-Patch-Box or MX-NPA-Box. Then insert the MOBOTIX patch cable into the box and secure the cable using the bayonet catch.

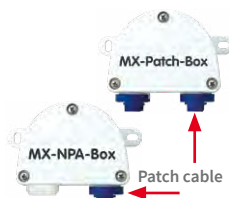

More information on installing an *MX-Patch-Box* or *MX-NPA-Box* is available at www.mobotix.com under **Support > Download Center > Documentation > User Manuals > Accessories > Interface Boxes**.

Insert the MOBOTIX patch cable of the S26 into the network port for standard connections (only permitted in indoor areas).

If additional cables are required inside the housing (MxBus, microphone, speaker), they must be connected as described in Section 2.4.3, «Connecting Additional Cables».

2.4.2 Network Cabling for S26 with Installation Cables

1. **Remove housing cover and cable plugs:** Loosen the Allen screw on the housing cover of the S26 and remove it. Push the cable plug in the camera out of the housing from the inside to the outside (red arrow).



2. **Attach the cable ties:** Feed one of the cable ties supplied through both slots in the circuit board underneath the LSA cutting clamp.

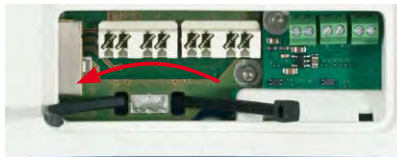

3. **Prepare the installation cable:** Cut the installation cable to length, feed through the white single wire plug (5-7 mm/0.2 to 0.28 in), remove 35 mm/1.38 in of insulation and separate into individual twisted wire pairs including 15 mm/0.6 in sheathing. Wind the shield mesh around the sheath to a width of 10 mm/0.4 in so that it can be fixed on the contact surface later using the cable tie.

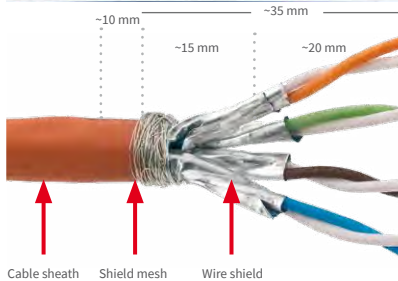

4. **Secure the cable:** Push the plug out and insert the installation cable with single wire plug (5-7 mm/0.2 to 0.28 in) into the opening intended for the installation cable. The rubber sleeve must sit tightly on the installation cable to prevent the penetration of moisture. Tighten the cable tie around the shield mesh to ensure less tension.

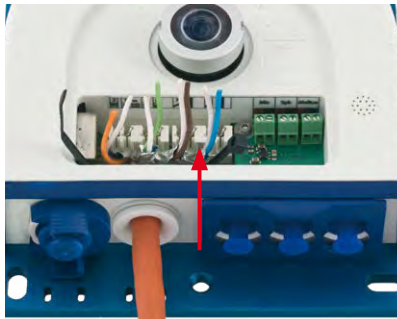

Ensure that the installation cable is fed right into the housing when the camera is in the right position so that the cable plug provides optimal sealing for the housing

5. **Connecting the cable wires:** The individual wires of the installation cable can be connected to the LSA cutting clamp using an appropriate tool and in accordance with the EIA/TIA-568A or B standard used (see printed color coding above the clamp; see red arrow in the illustration below).

Caution

Make sure that **all cable end offcuts are removed from inside the camera**. If not, this could lead to **short circuits!**

Hint: Hold the cable ends firm before cutting them with the LSA+ tool.



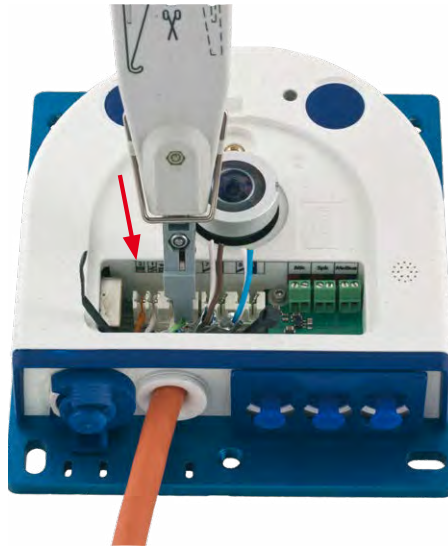

Only use the LSA/
Krone blade and set
to LOW impact!



If additional cables are required inside the housing (MxBus, microphone, speaker), they must be connected as described in Section 2.4.3, «Connecting Additional Cables».

2.4.3 Connecting Additional Cables

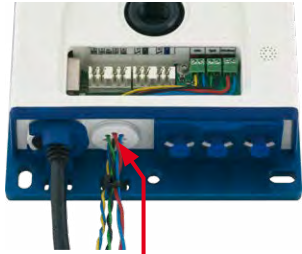
Additional cables can be fed through the free opening in the housing, depending on the Ethernet connector used (patch cable or installation cable). If an installation cable is used, additional cables should be installed **after** the installation cable has been fitted.

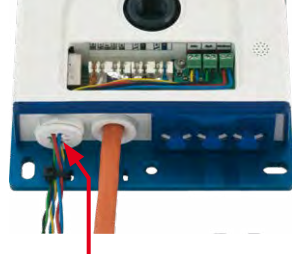
Ethernet via Patch Cable	Ethernet via Installation Cable
 <p data-bbox="123 638 352 678">Additional cables (MxBus, microphone, speaker)</p> <ol data-bbox="89 718 448 798" style="list-style-type: none">1. Replace any single wire plugs with appropriate cable plugs (M.4/5) for additional cables. 	 <p data-bbox="504 638 733 678">Additional cables (MxBus, microphone, speaker)</p> <ol data-bbox="470 718 828 853" style="list-style-type: none">1. Remove the bayonet catch and the patch cable and push the single wire plug or appropriate cable plug (M.4/5) in so that the edges protrude inside. The bayonet catch will no longer be used.

2. Push the single wire plug with the individual wires through or push the cable with sheathing through the cable plug.

3. Connect the wires to the corresponding screw terminals with the help of the screwdriver supplied.



4. Fix single wires or cables to the base plate using one of the cable ties supplied.

5. Connect wires to the corresponding devices (MxBus module, microphone, speaker).



2.4.4 Power Supply Using a Switch

1. Connect the factory pre-installed cable of the camera to the **Camera** connector of the PoE adapter.
2. Connect the **LAN/Power** connector of the PoE adapter to the Ethernet connector of the switch/router or the Ethernet port.
3. Plug the RJ45 connector of the power supply unit into the **PC/Power** connector of the PoE adapter.

The IP addresses in the diagram are shown only as an example

For the S26 you should use the blue MX-NPA-PoE-Set or the MX-NPA-Box – previous MOBOTIX network power accessories, such as the NPA-Set, Power-Box and Power-Rack (MX-NPA-Set, MX-NPR-4 and MX-NPR8/20) are not suitable for use with the S26

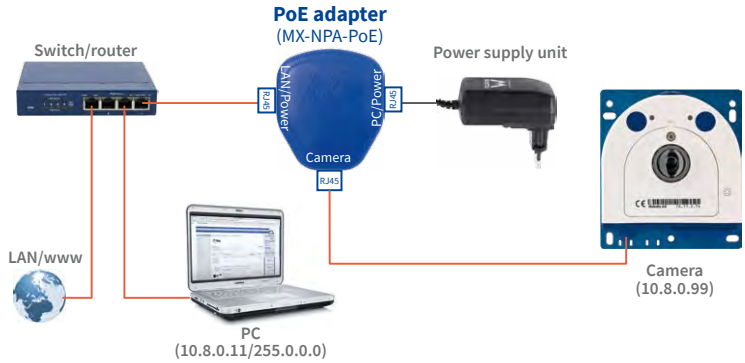

2.4.5 Power Supply When Connected Directly to a Computer

1. Connect the factory pre-installed cable of the camera to the **Camera** connector of the PoE adapter.
2. Connect the **PC/Power** connector of the PoE adapter to the Ethernet port of the computer.
3. Plug the RJ45 connector of the power supply unit into the **LAN/Power** connector of the PoE adapter.

The IP addresses in the diagram are shown only as an example

The PoE adapter replaces the crossover cable when directly connecting to a computer

For the S26 you should use the blue MX-NPA-PoE-Set or the MX-NPA-Box – previous MOBOTIX network power accessories, such as the NPA-Set, Power-Box and Power-Rack (MX-NPA-Set, MX-NPR-4 and MX-NPR8/20) are not suitable for use with the S26

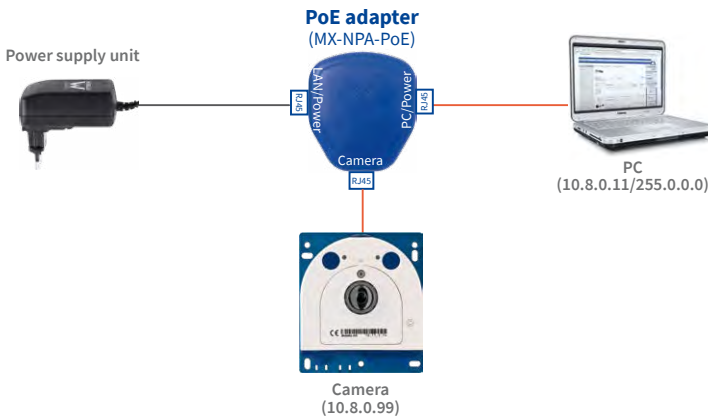

2.4.6 Power Supply with Power-Over-Ethernet Products

Connect the factory pre-installed cable of the camera to the Ethernet connector of the PoE switch/router. The switch/router must support the PoE standards IEEE 802.3af or IEEE 802.3at.

The IP addresses in the diagram are shown only as an example

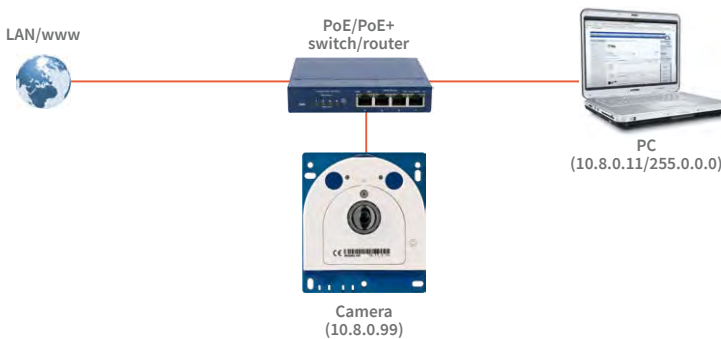

2.4.7 Variable PoE

The power consumption of the camera depends on the functions in use as well as any peripheral devices connected (see table). PoE classes 1, 2 or 3 may be selected in the browser-based user interface in order to optimally adjust the camera to your system design (PoE switch in use, emergency power concept, etc.).

PoE Power Level Classes (IEEE 802.3af Standard)		
Class	Max. power consumption	Camera operating mode and peripheral devices
1	0.44 W–3.84 W	LowPower mode; no peripheral devices (available soon)
2	3.84 W–6.49 W	Normal mode; max. 1 W for MxBus peripheral devices
3	6.49 W–12.95 W	FullPower mode; max. 2.5 W for MxBus peripheral devices (for example, MX-GPS-Box and MX-232-IO-Box to MxBus), max. 4 W for peripheral devices to MxBus and USB interface

Caution

If the total power consumption of the camera and peripheral devices exceeds the power provided by the PoE switch for the specified class, the switch can disconnect the camera from the power supply. ***In this case, the camera will only be accessible again once the peripheral devices have been disconnected from the camera and the camera has been restarted.***

Variable PoE: Multiple cameras can be operated simultaneously from the same switch

The default setting is usually fine, and nothing needs to be changed. However, the PoE power class must be changed in the browser if a higher or a lower power class is required for your application:

1. Select Admin Menu > Network Setup > Ethernet Interface (for experts).
2. Click on **Change** under **Power Supply**.
3. A **Power Wizard** will appear to guide you through the PoE configuration steps.
4. Next, restart the camera: Disconnect the camera from the power supply. Then reconnect it, for example, by disconnecting and then reconnecting the Ethernet cable at the PoE switch.

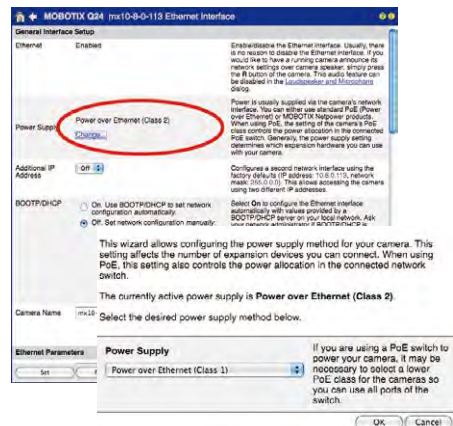

Download the free-of-charge MxManagementCenter software at www.mobotix.com

1 OPERATING THE CAMERA

1.1 Manual and Automatic Operation

MOBOTIX cameras do not require any extra software. Thus, you can set up and operate the MOBOTIX camera using a JavaScript-enabled browser on all common operating systems (such as Windows, Linux, Macintosh, etc.). As an alternative, you can also use the MOBOTIX application MxManagementCenter. Follow these steps to set up the camera:

1. **Connect the camera to the network.**

Power is supplied directly via the Ethernet cable (see Section 2.4, «Network and Power Connection, Additional Cables»)

2. **Establish a connection to the camera and adjust the network settings, if required.**

By factory default, MOBOTIX cameras are booting as DHCP client with an additional fixed IP address in the **10.x.x.x** range (e.g., **10.16.0.128**). Local computer networks usually have IP addresses in the 172 or 192 ranges. Depending on whether a DHCP server is present on the local network (e.g., a DSL router) or if the network has been set up to use fixed IP addresses, there are several possibilities for establishing a connection to the camera and to change its network parameters:

- **Network with DHCP server**

- Using a browser:

If you know the IP address that the DHCP server assigned to the camera, simply enter that address in the browser address bar to directly connect to the camera (see Section 4.1.1, «First Images and the Most Important Settings in the Browser»).

- Using MxManagementCenter:

With MxManagementCenter, you can show and integrate the camera without having to know its current IP address (see Section 4.1.2, «First Images and Network Parameter Configuration in MxMC»).

- **Network with fixed IP addresses**

In order to access the camera, it must have an IP address within the range of the local network. To set the camera's network parameters, you can use one of these methods:

- Manually using a browser:

First, you need to change the network parameters of your computer (see Section 4.1.1, «First Images and the Most Important Settings in the Browser» and following ...).

- Integration into MxManagementCenter with automatic adjustment of the camera's IP address:

The camera is displayed in MxManagementCenter despite the fact that the IP address is not part of the local network. The application allows reconfiguring the network parameters accordingly (see Section 4.1.2, «First Images and Network Parameter Configuration in MxMC»).

3. Configure the camera.

Using the web-based user interface or MxManagementCenter.



Camera software in browser

3.1 First Images and the Most Important Settings

Once the MOBOTIX camera has been connected to the network, you need to set up the camera's network interface accordingly. This step involves setting up and checking the network parameters of the camera. If your network has an active DHCP server or is already using an IP address in the 10.x.x.x range with a 255.0.0.0 network mask, you do not need to change the camera's network parameters. You can access the camera directly (see Section 4.1.1). If your network or computer does not use an IP address in the 10.x.x.x range (for example, in the 192 or 172 ranges), you should follow one of the following methods for changing the camera's network parameters:

- **Manual Setup** (see Section 3.1.1, «Manually Setting Up the Network Parameters in a Browser»)
- **Automatic setup using MxManagementCenter** (see Section 4.1.1, «First Images and the Most Important Settings in the Browser»)

Pressing the key (see Section 6.1.4, «Using the Start Options of the Camera») will prompt the camera to announce its current IP address on the camera speaker

Note

We will use a camera with the factory address 10.8.0.99 in the following examples. Replace this IP address with the IP address of your camera. You will find the IP address of your camera on a small sticker on the camera. Make sure that the IP addresses used in the following examples are not already being used by other devices in the network.

3.1.1 Manually Setting Up the Network Parameters in a Browser

You need a computer that is using a 10.x.x.x IP address in order to manually set up the network parameters of the MOBOTIX camera. The computer's network parameters usually have to be changed for this purpose.

1. Change the Network Parameters of Your Computer:

Windows (XP, Vista and 7):

1. Open **Start > Settings > Control Panel > Network Connections**. Clicking on **Properties** opens the dialog box shown.
2. Double-click on **Internet Protocol (TCP/IP)**. On the **General** tab, activate the Use the following IP address option. Enter an IP address in the 10.x.x.x range in this field (for example, 10.8.0.11).
3. Once all dialog boxes have been closed, the computer will have the IP address 10.8.0.11.

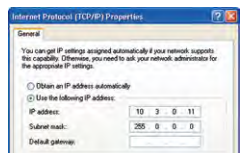

Entry in "Subnet mask" field: 255.0.0.0

First Images and the Most Important Settings

Windows 8.1/10:

1. Open **Start > Settings > Control Panel > Network Connections**. Clicking on **Properties** opens the dialog box shown.
2. Double-click on **Internet Protocol (TCP/IP)**. On the **General** tab, activate the Use the following IP address option. Enter an IP address in the 10.x.x.x range in this field (for example, 10.8.0.11).
3. Once all dialog boxes have been closed, the computer will have the IP address 10.8.0.11.

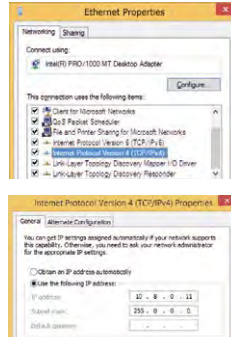

Entry in "Subnet mask" field: 255.0.0.0

Linux/Unix:

1. Open a terminal as **root** user.
2. Enter the following command: `ifconfig eth0:1 10.8.0.11`
3. The computer is now also using the IP address 10.8.0.11

Mac OS X/macOS:

1. Open **System Properties > Network**.
2. Select **Ethernet**. In the **Configuration** field, select **Manual** and enter a 10.x.x.x IP address (for example, 10.8.0.11).
3. Click on **Apply** on the bottom right-hand side of the dialog box to assign the computer the IP address 10.8.0.11.

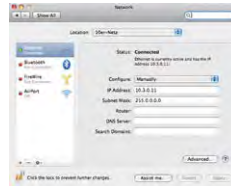

2. Set Up the Target Network Parameters of the MOBOTIX Camera:

1. Open a web browser on the computer and enter the default IP address of the MOBOTIX camera in the address bar of the browser (for example, 10.8.0.99). Pressing Enter displays the user interface of the MOBOTIX camera (see also Section 4.1.1, «First Images and the Most Important Settings in the Browser»).
2. Click on the **Admin Menu** softbutton in the user interface of the MOBOTIX camera. The Quick Installation starts automatically once the admin user has logged on.
Note: The Quick Installation can also be executed at a later stage by opening **Admin Menu > Network Setup > Quick Installation**.
3. Enter the target network parameters of the camera on the appropriate page of the Quick Installation assistant.

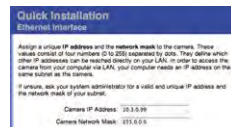
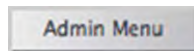

Default user data

User name: **admin**
password: **meinsm**

Note: The network parameters can also be modified retrospectively via **Admin Menu > Network Configuration > Quick Installation**.

4. Once you have completed the Quick Installation and rebooted the camera, the new network parameters will be activated. The camera can now be connected to the target network and, if required, further configured.

First Images and the Most Important Settings

4.1.1 First Images and the Most Important Settings in the Browser

Once the MOBOTIX camera has been connected to the power supply and to the network, you can access the user interface with the live camera image in the web browser. Internet Explorer, Firefox, Safari or any other graphical browser with activated JavaScript is suitable. It does not matter which operating system is used.

After entering the camera's IP address in the browser's address bar, you will see the live view of the MOBOTIX camera with its user interface controls, such as softbuttons, buttons for the different camera screens, pull-down menus (Quick Controls), icons for accessing the online help and the camera status, and status information elements.

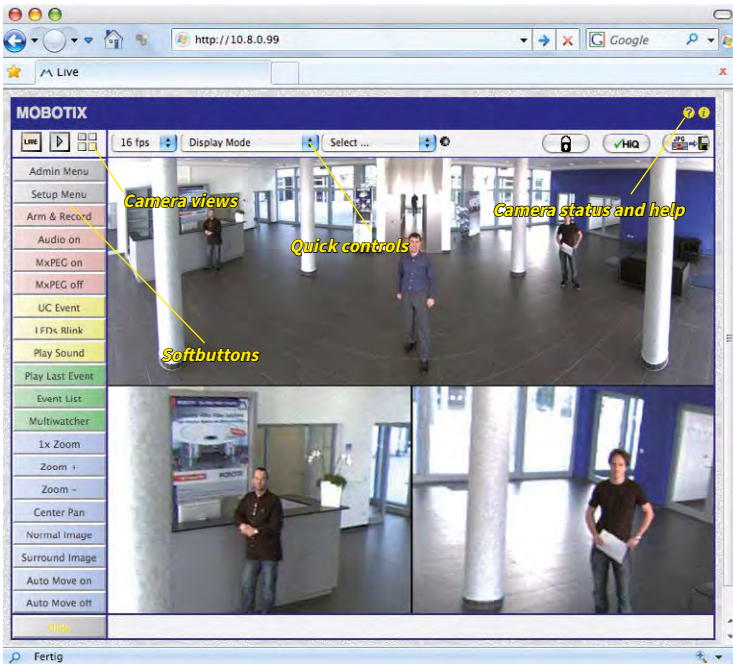

Note

Default access data for the administration menu

- User name: **admin**
- Password: **meinsm**

(Note that you need to change the password upon your first login – camera release V5.1.x and higher.)

Camera Views: Live, Player, MultiView



Live view:
<http://<camera IP>/control/userimage.html>

The MOBOTIX camera automatically displays the **live** screen when it starts up (factory default setting). You can set a different start page in **Admin Menu > Language and Start Page** (for example, the **Guest** screen) to allow a restricted access to the live image.

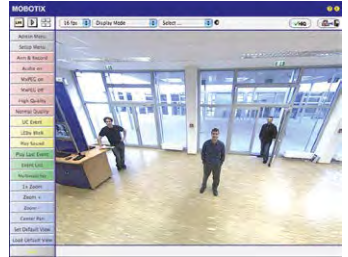

Player screen: <http://<camera IP>/control/player>

The other available standard screens include **Player** (playback of recorded images and video sequences) and the **MultiView** screen (displays several cameras with live or recorded images).



MultiView screen:
<http://<camera IP>/control/multiview>

Guest screen: <http://<camera IP>/cgi-bin/guestimage.html>

MultiView allows you to view several cameras via a "proxy" camera (especially useful if you want to access your cameras from outside of the network with reduced bandwidth).

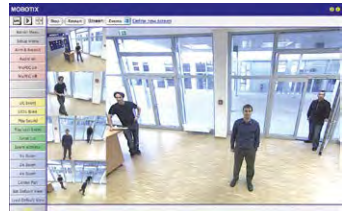

Note

For more information on camera screens, see the online help of the camera's user interface in the browser.

4.1.2 First Images and Network Parameter Configuration in MxMC

Installing and Starting MxManagementCenter

Download the current version of MxManagementCenter from the MOBOTIX website (www.mobotix.com > **Support** > **Download Center** > **Software Downloads** in the MxManagementCenter area). Double-click the shortcut for the program or the program file.



Finding Cameras

When starting MxManagementCenter for the first time, the configuration wizard opens and automatically starts searching for MOBOTIX cameras. The number of found cameras is shown next to the Add button. This number is updated automatically if the number of MOBOTIX cameras on the network has changed (i.e., by connecting new/disconnecting existing cameras)..

Download
MxManagementCenter
for free from
www.mobotix.com

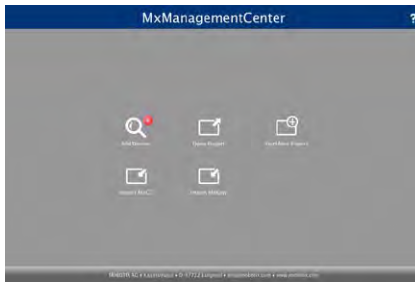

Click on **Add Devices**. The cameras are displayed either in a list or as tiles. Use the **List** and **Tile** buttons to change the display mode.



MxManagementCenter automatically monitors and displays the operating status of all cameras. Cameras that are not on the same subnet as the computer are indicated by the icon (Camera not in the same network as the computer). Likewise, the cameras that have an unknown password or for which no user name/password combination has been specified in MxManagementCenter will be displayed with the icon (Camera is password-protected).

Reconfiguring Network Addresses of Cameras

Using Bonjour*, MxManagementCenter finds not only cameras on the same network as your computer, but also MOBOTIX cameras located in other subnets (status: ) . In such a case, you would not be able to establish any connection to cameras in a different network or subnet.

This is the case, for example, if you are integrating cameras into a network without DHCP server (i.e., with fixed IP addresses) and the IP address range is different from the 10.x.x.x range supported by the cameras in addition to DHCP.

MxManagementCenter can automatically configure such a camera so that it is "integrated" into your existing network. To do so, you have to select the respective camera and then click on the  button at the bottom of the program window.

The **Network Setting** dialogue opens.

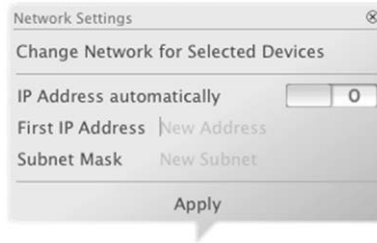

If you have assigned a fixed IP address to your computer, you will certainly prefer to assign fixed IP addresses to the cameras. To do so, enter the IP address and the subnet mask. The IP address is incremented automatically for each selected camera.

When you click on **Apply**, the selected cameras are automatically reconfigured and they are located in the same subnet as the computer.

First Images and the Most Important Settings

Adding Cameras

After a camera has been reconfigured, it has the status **Accessible** and can be integrated into MxManagementCenter.

Select the desired cameras (use **Cmd-click** to select several cameras). If the cameras are password-protected **1**, click on **Edit User and Password** **2** and enter the user name and password.

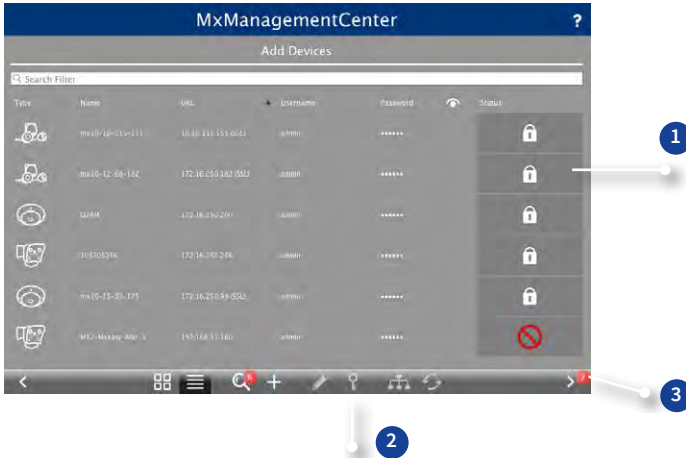

The number of selected cameras is shown on the **Next** button **3**. Move to the next page and click on **Finish**.

For more information, see the **MxManagementCenter Tutorial**, which can be downloaded as a PDF file from the MOBOTIX website: www.mobotix.com > **Support** > **Download Center** > **Documentation** > **Brochures & Guides** > **Tutorials**.

4.1.3 Start Options of the Camera

By default, the camera starts as DHCP client and automatically tries to get an IP address from a DHCP server. To start the camera in a mode different from the default mode, you can activate the boot menu of the camera.



LED default settings:

- 1 Power (on), Error (flashing)
- 2 Recording (flashing)

Preparing the Camera

- Disconnect the camera's power supply.
- Reconnect the power supply of the camera.

Activating the Boot Menu

The right LED lights up red 5 to 10 seconds after establishing the power supply and will stay on for 10 seconds. Briefly press the key indicated by the red circle in the figure. The camera enters the boot menu, ready for selecting one of the start options.

The LED now flashes once and repeats the flash signal after pausing for one second (the number of flashes indicates the current start option). To go to the next start option, briefly press the key again (< 1 sec). After the last start option, the camera returns to the first option (LED flashes once).

LED flashes	Start Option	Meaning	Audio Confirmation*
1 x	Auto Configuration	Starts the auto configuration in order to operate this camera as a door station (variant Mx-S26B only, camera software V5.2.x and higher).	Phone ringing
2 x	Factory Defaults	Starts the camera with factory defaults (factory default IP address, users and passwords will not be reset).	Boing
3 x	Automatic IP Address	Starts the camera as DHCP client and tries to obtain an IP address from a DHCP server. If a DHCP server cannot be found or no IP address can be obtained, the camera starts with its factory default address.	Boing Boing
4 x	Recovery System	Starts the camera with the recovery system, e.g., in order to recover from a failed update of the camera software.	Alarm Sound

*Only on cameras with audio option and installed speaker.

Selecting a Start option

Press the key longer (> 2 sec). The camera confirms the selection by flashing rapidly three times. You can now remove the paper clip. After 20 sec, the camera will confirm the selection by playing a sound according to the table above.

If nothing is selected, the camera will resume its normal boot process after a certain time.

Starting the Camera with Factory Default (Network) Settings

If you use the camera's **start option 2** to load the factory configuration, this configuration is not automatically saved in the camera's flash memory. When the camera is next rebooted without using **start option 2**, the last stored configuration will be used. To permanently store the new configuration in the camera's flash memory, open **Admin Menu > Store**. Note that you can restore specific parts of the camera configuration afterwards by using "Restore" to re-apply the settings still stored in the camera.

As opposed to resetting the camera using **Admin Menu > Reset configuration to factory defaults**, the **user information** will **not** be reset if the camera is booted using the factory settings.

Make sure you store the default network configuration to the permanent flash memory

Starting the Camera with an Automatic IP Address (DHCP)

Starting the camera using **start option 3** and an automatic IP address (DHCP) is only **temporary**. The network configuration of the camera can be permanently set to DHCP (factory setting) under **Admin Menu > Ethernet Interface**.

Make sure that the network has a functioning DHCP server when starting the camera with DHCP support. If this is not the case, the camera cannot obtain a valid IP address and will use its last IP address.

You should also make sure that the cameras always obtain the same IP addresses by permanently assigning the MAC addresses of the cameras to the desired IP addresses.

In case of an error, the camera uses its last IP address

Tip: Briefly pressing the **key of the camera** will announce the current IP address via the speaker.

4.1 Virtual PTZ and Full Image Recording

4.1.1 Preparing the Virtual PTZ Function

The virtual PTZ function allows you to use a mouse or joystick to continuously zoom in on images from the selected video source and "virtually" move the enlarged image section within the entire image sensor area.



Greater ease of use through a joystick



Operation Using The Mouse And Scroll Wheel

The vPTZ function of the S26 can be controlled in the browser using the mouse. This position becomes the new image center by clicking on any position on the image displayed on the monitor. The image moves accordingly and the image distortion is automatically corrected. The **scroll wheel** can be used to control the zoom function. This functionality is disabled in the default settings of the camera and must therefore first be activated. To do this, go to **Setup Menu > vPTZ Settings**, disable **Lock Mouse Wheel Zoom**, click on **Set** and then on **Close** to save your settings. You can now use the scroll wheel to zoom + (roll upwards) or zoom - (roll downwards).

Virtual PTZ and Full Image Recording

Operation Using USB Joystick

A standard USB joystick can drastically improve vPTZ operation for the user – in the browser and in MxManagementCenter. Please first install the joystick on the PC according to the manufacturer’s instructions.

In order to use a USB joystick in the browser, make sure that you have a PC with a Windows operating system and the latest version of Internet Explorer and that the “ActiveX” mode in the camera software (browser) is activated:

- Switch to **Browser** in the Quick Control.
- Under **Browser**, select the option **ActiveX** in the field to the right. The USB joystick can then be used until the browser is closed.
- To store the setting permanently, **ActiveX** must be activated in the **Admin Menu**. To do so, use **Language and Start Page** in the Admin Menu.
- Under the page options, select the **ActiveX** operating mode.
- Store the settings permanently in the camera by clicking on **Set** and **Close**.
- The joystick can now be used.

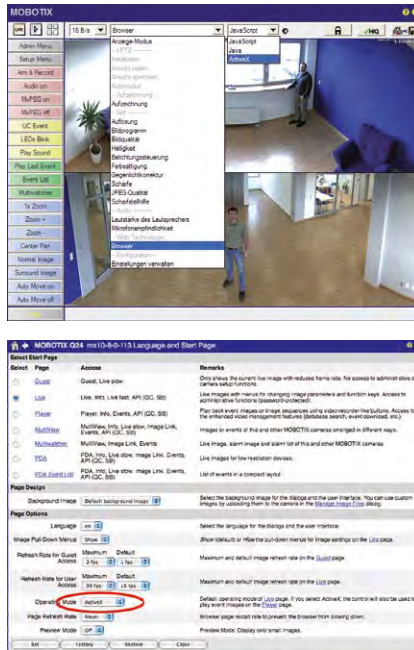

Notes

You will find more information and details on vPTZ in the camera’s online help topic «vPTZ Settings».

4.1.2 Full Image Recording

It is possible to record a **full image**, regardless of the live image stream that is being displayed. This ensures that the recording always contains the full image of the lens used, even though the operator may have used the vPTZ features to zoom into the image in order to examine a specific detail.

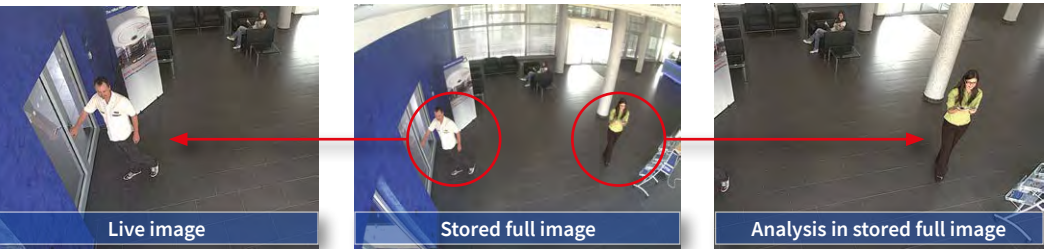

Stored full image:
Original camera image
without distortion or
image correction

This means that you can use the vPTZ features in VGA resolution to pan, tilt and zoom in the live image while the camera is, for example, recording full images at 1 fps in MEGA or 6MP resolution.

In **MxManagementCenter**, the recorded full images may be prepared for the user with the vPTZ functions (for example, panning and zooming in on an image detail such as a doorway).

If **full image recording is not activated**, only the last displayed live image will be saved (save what is seen). The **main benefit** of live image storage is to ensure that the full power of the camera processor is used for live image correction and maximum frame rates. The **main advantage of full image recording** lies in the special functionality of the D14D, in that it can always ensure the availability of a maximum size (full) image for later searches, despite vPTZ actions carried out on the live image. The mechanical limitations of motor-driven PTZ cameras mean that they simply **cannot** provide this unique advantage to the user!

Notes

Post-event search in the full image: If you are using Full Image Recording on D14D cameras, you should use at least MEGA resolution when storing. This will facilitate later searches in **MxManagementCenter**. The advanced distortion correction features require this function to deliver satisfactory image quality.

Full image recording on: Due to the increased processing time, full image recording reduces the data rate of the live image stream, which may drop by around 10 to 30 percent. We therefore recommend reducing the frame rate for storage as much as possible to affect the live image stream as little as possible.

Full image recording off: The event that triggered a video motion (VideoMotion VM) window may not be in the recorded sequences while the window was not displayed at the time.

Virtual PTZ and Full Image Recording

Activate/Deactivate Full Image Recording in the Browser

To configure this feature, open the **Setup Menu > Event Control > Recording** dialog box and activate or deactivate the **Full Image Recording** option.

The screenshot shows the 'Recording' dialog box for a MOBOTIX Q24 camera. The 'General Settings' section is active, showing various recording options. The 'Full Image Recording' option is highlighted with a red circle and is set to 'On'. The 'Explanation' column provides details for each setting.

General Settings	Value	Explanation
Arming	Enable	Arm Recording: Controls camera recording. Enable: activate Recording. Off: deactivate Recording. SI: Recording armed by signal input. CS: Recording armed by custom signal as defined in General Event Settings. From Master: copies Recording arming state from master camera.
	(no time table)	Time Table Profile: Time table profile for time-controlled recording. (Time Tables)
Digital Signing	Off	Digital Signing: Digitally sign the recorded image files using the X.509 certificate of the web server. Manage X.509 certificates of the web server.
Recording Status Symbol	Off	Activate Recording Status Symbol: On will draw a symbol in the image to visualize the current arming and recording status.
Full Image Recording	On	Activate Full Image Recording: On will always record the Full Image of the sensor with the specified parameters. On will record the visible image.
Terminate Recording (TR)	Off	Activate Terminate Recording: Terminate recording if an event is detected. Use this option to freeze stored images. Click here to resume recording.
Storage Settings	Value	Explanation
Recording (REC)	Event Recording	Recording Mode: Type of event and story recording. Snap Shot Recording: stores single JPEG pictures. Event Recording: stores stream files for every event using MxPEG codec. Continuous Recording: continuously streams videodata to stream files using MxPEG codec.
	Include audio	Record Audio Data: Store audio data in stream file if available. Enable and configure microphone.
Start Recording	All (EC - Event Counter) (EL - Event Logic) (EG - Event Logic 2)	Start Recording: Select the events which will start recording. Use (Ctrl) Click to select more than one event. Events in brackets need to be activated first. EC or EL for filtered events.

Buttons: Set, Factory, Restore, Close, Less

The screenshot shows the 'Full Image Recording' dialog box for a MOBOTIX Q24 camera. The 'Attribute' section is active, showing settings for image quality and display options.

Attribute	Value	Explanation
Image Size	QXGA (2048x1536)	Image Size: Factory default: Mega (1280x960)
JPEG Quality	60% (High)	JPEG Quality: Factory default: 60%
Text Display	Date & time	Text Display: The Date & time option will only display date and time.
	Date & time	Date and Time: Select format of date and time.

Buttons: Set, Factory, Restore, Close

4.1.3 Special Configuration in the Browser

Thanks to its hemispherical lens, the MOBOTIX S26 provides certain special configuration options for the image settings. Depending on where the camera is mounted (ceiling or wall) and on the live image display preferred by the user, certain important basic settings and, if necessary, their adjustment must be configured when a S26 is first installed.

Configuration of the S26 Basic Parameters

Complete the steps described below in the browser window:

1. **Log onto the camera and boot it** as described in Section 3.1, «First Images and the Most Important Settings».
2. **Select mounting position wall/ceiling/floor:** Click on **Installation** in the Quick Control panel and then select **Wall**, **Ceiling** or **Floor** according to the mounting position of the camera. **Ceiling** always means that the orientation of the camera or sensor module is from **top to bottom** and for **Floor**, the camera or sensor module's orientation is from **bottom to top**.

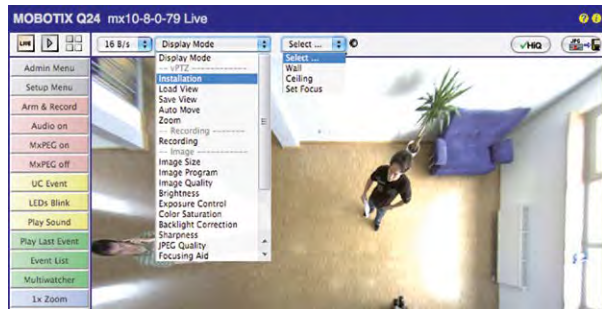

As a result, you will get a **perspective-corrected panorama view** for each image sensor matching the specified mounting position. Panorama view is set as a factory default and it can be changed as described below.

3. Switch to the **Display Mode** Quick Control.
4. Set the mode that you want to be the standard view. For demonstration purposes, the descriptions below describe the typical display mode for the wall mount and the ceiling mount, **Panorama** and **Surround** respectively. Every other display mode can be operated in the same way.

Wall-Mounted: Setting and Correcting the Standard View "Panorama"



Camera live image with panorama correction

1. In the **Display Mode Quick Control**, select the option **Panorama**. Examine the image that is now displayed. If the section meets your expectations, no further adjustment is necessary, and panorama configuration is complete. To change the image section to meet your specific expectations, continue with Step 2.

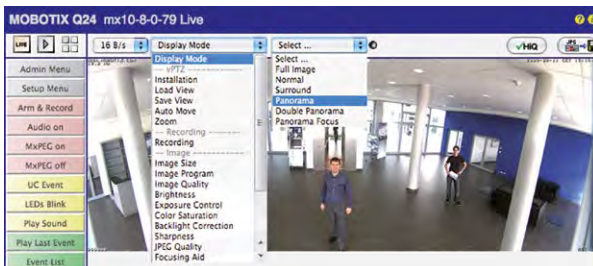

Camera live image **without** MOBOTIX panorama correction with Quick Controls visible

Note

The currently visible image section may differ from the desired image section due to the installation position or any accessories in use, for example. However, it is not necessary to physically move the camera, as in this case the browser alone can be used to adjust the visible panorama image by zooming, panning and tilting. Tilted vertical lines may also be optically straightened to the image edges using the panorama correction function. These tilted lines are primarily caused if the camera or sensor module is tilted (for example, due to mounting with 15° wedges) or if the image tilt is modified.

- Click on the **lock icon**. Clicking on the lock once opens it (lock clasp is raised). The lock prevents execution of later vPTZ actions, which could also unintentionally modify the view you configure. This holds for all overview display modes, that is, also for Panorama/Focus, Double Panorama and Surround.



Open lock



- A new icon for processing the panorama image appears in the top left corner of the camera image. Enlarge the image by clicking on the icon once (OnScreen Control appears).



Click on the icon

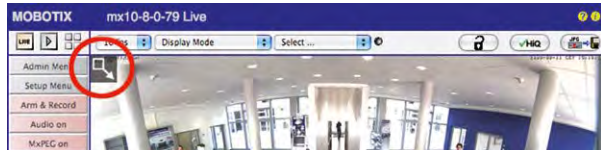

- Using the **OnScreen Control** visible in the live camera image, you can now change the displayed live camera image as desired (panning, tilting, zooming, rotating and panorama correction; see fig. on the right). When doing so, the vPTZ function using the mouse or joystick is deactivated.

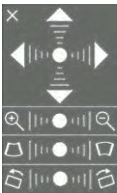

Camera live image *with* panorama correction with OnScreen Control visible

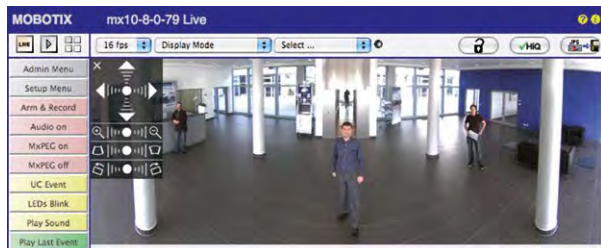

- After you have modified the desired setting, close the control panel (x in the top left hand corner).
- Click on the **lock icon again** to close it (lock clasp is down). The panorama image setting is then locked until the camera is next restarted.

Caution

To permanently save the standard image setting defined for the S26, go to the **Store Complete Configuration** option in the **Manage Settings** Quick Control. The settings will then remain in effect, even after rebooting.

Virtual PTZ and Full Image Recording

Functions of the S26 OnScreen Control

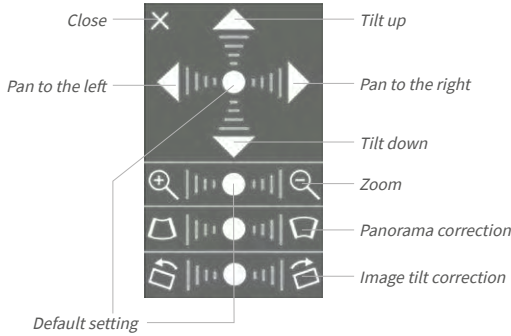

To use the OnScreen Control, click on the arrows in the top area for shifting the image section. In the bottom areas, which are displayed when needed, click to the left and/or right of the center point.

The same applies for every area: **The further away that you click from an area's center point, the greater the change triggered.** To reset an area, click on its center point again.

During panorama correction, clicking between the two trapezoid symbols straightens the left or right tilting lines, which are best visible at the edges of the image section.

Depending on the mounting position (ceiling, wall, floor), panorama correction and mounting error correction may not be available!



Bring columns together at the **top** (necessary to correct the example on the left)



Bring columns together at the **bottom**

Ceiling-Mounted: Set North (User-Defined North Direction)

Once the camera has been mounted on to the ceiling, you need to specify its North direction. This is not the "true" direction of North but rather the **main line of sight or the focus** of the camera or sensor module. It serves as a reference for the North direction in the **Surround** and **Double Panorama** display modes (the **Ceiling** option was already selected in the **Installation Type Quick Control**).

1. In the case of a double image, click on the corresponding sensor module (camera image) and select the **Normal** option from the **Display Mode Quick Control**.



For vPTZ use and the configuration of a USB joystick, see Section 4.1.1, «Preparing the Virtual PTZ Function»

2. Rotate the live image in the desired direction using the mouse or a joystick connected to the computer.

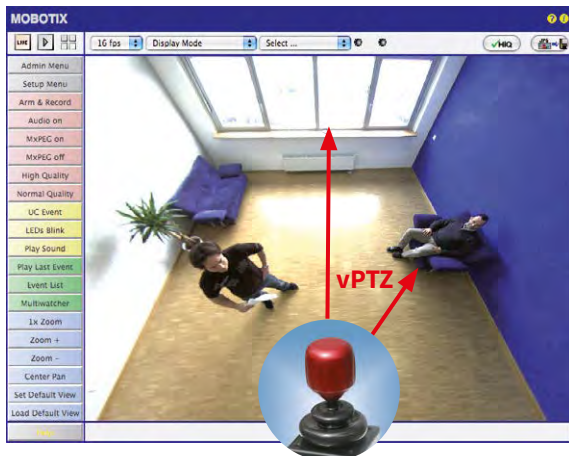

Virtual PTZ and Full Image Recording

- In the **Installation Quick Control**, select the **Set North** option.

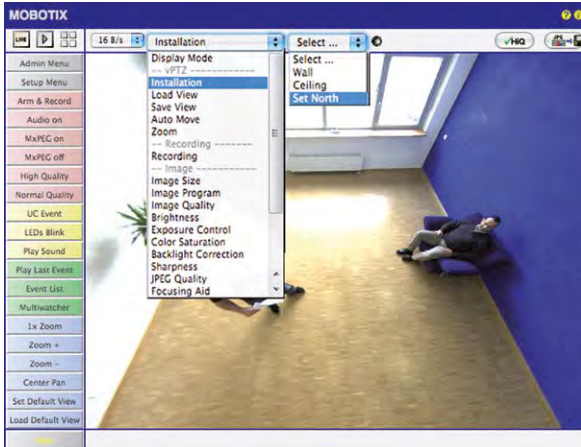

- Store the desired North direction permanently by first activating the checkbox and then clicking on Yes.

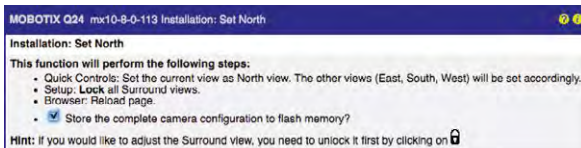

- You have now set the North direction for the **Surround** and **Double Panorama** display modes. In the next step, you can set these views as the standard view for the camera live image.



In the **Display Mode Quick Control**, select the option **Surround** or **Double Panorama**. You can fine-tune the views using the vPTZ via mouse or joystick and, as described above, by unlocking and locking the standard view using the lock icon (open lock, correct display and close lock again).



Note

For each of the **subviews** (*North, East, etc.*), the **OnScreen Control** on the side can be used to adapt it (open lock, click on subview, adapt view, click on next subview, adapt view and close lock again).

Configuration of Audio Settings

Thanks to the MOBOTIX S26 system's flexible layout, there are a number of different microphone options depending on the model used (S26, S26).

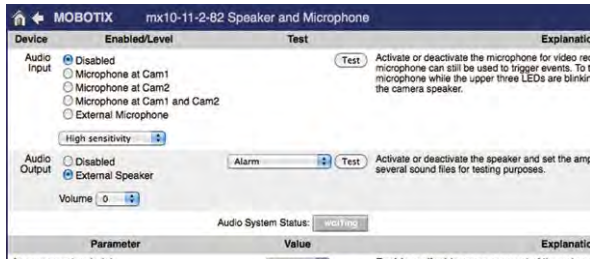

Information on how to connect external microphones and speakers is provided in Section 2.2.7, «External Audio Support (Microphone/Speaker)».

Microphone for the S26

You have to use an external microphone with this camera.

Speaker for the S26

Since the S26 does not have a built-in speaker, this function can only be used to activate/deactivate an external speaker.

5.1 MicroSD Card Recording

5.1.1 Introduction

Flash-based storage devices (MicroSD cards, USB sticks and solid-state drives) do not contain any moving parts as compared to the commonly used hard drives. Flash-based storage devices are compact and highly resistant to moisture and vibrations. They feature low energy consumption and they do not lose any data in the event of a power failure, meaning that they are ideal for use with MOBOTIX cameras.



Flash memory devices: more robust than hard drives

Number of Write/Delete Cycles Per Flash Storage Cell

The number of write/delete cycles of every storage cell of a flash device is limited. The controller of the flash device automatically detects individual flash cells that are no longer functioning. The contents of the faulty cell will then be rebuilt using a checksum and will be moved to a properly working spare cell. The faulty storage cell will be marked as "bad" and will no longer be used. No data is lost in this process.

In addition, MOBOTIX cameras constantly monitor activated flash storage devices. MOBOTIX has developed a technology to test the wear of the flash device by logging the number of write/delete cycles (patent pending). The flash memory wear is automatically displayed in the status bar in the live camera image but it can also be viewed at any time in the **Admin Menu > Camera Status** dialog box.

Conservative Memory Usage Thanks to MOBOTIX MxFFS File System

MxFFS formatting of the MicroSD card means that MOBOTIX camera software will use the flash device as evenly as possible, thus allowing for the maximum possible number of write/delete cycles. This also means that all storage cells of the flash device will be written and deleted with the same frequency, if possible. MOBOTIX technology increases the life of the flash device considerably and also improves the security and the reliability of the storage process.

Storage Requirements and Life Expectancy of MicroSD Cards

The life expectancy of a MicroSD card increases proportionally to the storage capacity, since the camera software will execute fewer write/delete cycles on each storage cell. The first deletion will begin once the SD card has been filled to capacity (first full cycle).

MicroSD Card Whitelist for MOBOTIX Cameras

MicroSD cards are available in many different quality levels. When recording video data, the most important criteria are the write speed (speed class) and the life expectancy of the storage cells that is directly dependent on the type of storage cell used. The document "MicroSD Card Whitelist for MOBOTIX Cameras" on www.mobotix.com, **Support > Documentation > White Lists > MicroSD Cards** contains a list of MicroSD cards that have been tested with MOBOTIX cameras.

All specifications are based on calculated averages

32 GB MicroSD Card: Storage Requirements					
	6 fps CIF	6 fps VGA		1 fps MEGA	1 fps QXGA
	M-JPEG	M-JPEG	MxPEG	M-JPEG	M-JPEG
File size single image	15 kB	45 kB	-	120 kB	240 kB
Storage required per second	90 kB	270 kB	75 kB	120 kB	240 kB
Storage required per 24 hrs	7.8 GB	23.5 GB	6.5 GB	10.4 GB	20.8 GB
Time for one full cycle	4 days	1.3 days	4.8 days	3 days	1.5 days

4 GB MicroSD Card: Storage Requirements					
	6 fps CIF	6 fps VGA		1 fps MEGA	1 fps QXGA
	M-JPEG	M-JPEG	MxPEG	M-JPEG	M-JPEG
File size single image	15 kB	45 kB	-	120 kB	240 kB
Storage required per second	90 kB	270 kB	75 kB	120 kB	240 kB
Storage required per 24 hrs	7.8 GB	23.5 GB	6.5 GB	10.4 GB	20.8 GB
Time for one full cycle	12 hours	4 hours	14.4 hours	9.2 hours	4.4 hours

Caution

The MicroSD card's service life depends on production quality and frequency of use. Set the type of recording (event-controlled or continuous recording, frame rate, resolution) according to your specific requirements.

We recommend changing the pre-installed, high-quality MicroSD card once a year if you have it constantly set to continuous recording.

Monitoring The Cell Wear Of Flash Storage Devices (Patent Pending)

MOBOTIX uses its own technology for this purpose and has a pending patent. You can view the flash wear in the status bar of the live image or by opening **Admin Menu > Camera Status**. In addition, the camera can also send a warning message (for example, via e-mail) as soon as a critical error is detected when data is written to the SD card (**Admin Menu > Error Notification Function.**). The MicroSD card can then be replaced to ensure that any existing data is not lost.

File Server / Flash Device	
Type	SD Flash Card
File System	MxFFS
Flash Wear	1%
Transfer Buffer Usage	0% (0: 0%, max: 0%)
Lost Event Images	0
Sequences	1 (1 files)
Newest Sequence	1970-01-01 01:00:00 #0
Oldest Sequence	1970-01-01 01:00:00 #0
Current Usage	4.0 MBytes (0.4%)
Max. Size	936 MBytes

5.1.2 Formatting the MicroSD Card

Before a MOBOTIX camera can store image and video sequences on a MicroSD card, the card needs to be formatted as MxFFS (MicroSD cards supplied by MOBOTIX are already MxFFS-formatted). The following steps are necessary to format a storage device (**Admin Menu > Storage on External File Server / Flash Device**):

1. Make sure that there is a MicroSD card in the card slot of the MOBOTIX camera.
2. Click **Format** in the **SD Memory Card** line.



3. Note down the characters shown in the **Encryption password** field or enter your own password. Next, click **OK**.

Note: The **Secure deletion – Slow** option will ensure that any data on the MicroSD card is overwritten completely so that the data cannot be recovered in any way. However, keep in mind that this kind of safe formatting takes considerably more time.



4. In the next dialog box, enter the user name and the password of a user of the **admins** group and click **OK** to confirm.

The MOBOTIX camera now starts formatting the card. It takes 5 to 12 minutes to format an 8 GB MicroSD card if the **Secure deletion – Slow** option is disabled. If **Secure deletion – Slow** is enabled, this may take anywhere between 3 and 14 hours.



Once the formatting has been completed, you can activate the MicroSD card for recording (see next section).

Format SD card:
Admin Menu > Storage on External File Server / Flash Device

The **Secure deletion – Slow** option takes several hours. You can also use suitable applications on Windows, Linux/UNIX and Mac OS X/macOS systems to repartition and safely erase the SD card.

Caution

Make sure that you always wait until the formatting process has been completed before accessing the camera again. If the **Secure deletion – Slow** option is disabled, this usually takes just a few minutes. You can only access the MicroSD card once MxFFS formatting has been completed.

Formatting with the **Secure deletion – Slow** option enabled takes several hours. You can also use suitable applications on Windows, Linux/UNIX and Mac OS X/macOS systems to repartition and safely erase the MicroSD card.

Activate recording: **Admin Menu > Storage on External File Server / Flash Device**

4.1.1 Activating Recording

Follow these steps to activate the recording to a MicroSD card that has already been MxFFS-formatted (**Admin Menu > Storage on External File Server / Flash Device**):

1. Make sure that there is a MicroSD card in the card slot of the MOBOTIX camera.
2. Make sure that the MicroSD card is formatted in MxFFS format.
3. Activate the **SD Flash Card** option.
4. Click on **Set** and then **Close** to store the configuration.
5. Reboot the MOBOTIX camera (**Admin Menu > Reboot Camera**).

Once the camera has rebooted, make sure that the camera displays the **FR REC** symbols in its live image. If this is the case, the camera uses the MicroSD card as recording target. If not, you must activate the recording (see below).

Activating the Recording

If the **FR REC** symbols are not visible in the live image after rebooting, you need to activate the recording using one of the following methods in the web browser:

- Automatic activation by clicking on the **Arm & Record** softbutton. Confirm this in the Easy Dialog by clicking on the **Yes** button.
- Manual activation via the Quick Control **Recording > Recording on** or in **Setup Menu > Recording**.

Encryption and Authentication

All video data stored on the MicroSD card is encrypted to ensure security at all times. The password for this is defined during the card's formatting procedure and needs to be entered for authentication whenever the recordings are accessed (see next section).

5.1.1 Accessing Data on the MicroSD Card

The following options facilitate access to the stored image and video sequences on a MicroSD card:

- **In the web browser:** Play back the recorded event images without audio directly from the MicroSD card using the Playback view of the camera software.
- **In MxManagementCenter:** Play back the recorded video sequences with audio by accessing the MicroSD card in the MOBOTIX camera via the camera or with a direct access to the MicroSD card via a card reader connected to the computer (coming soon).

Caution

When using the MicroSD card from one MOBOTIX camera in another MOBOTIX camera, you need to make sure that the time on the original camera is in sync with the new camera. We recommend using automatic time synchronization via a time server (**Admin Menu > Date and Time**).

5.1.2 Deactivating Card Recording

Follow these steps to deactivate the memory on a MicroSD card (**Admin Menu > Storage on External File Server / Flash Device**):

1. Activate the **None** option.
2. Click on the **Set** button at the bottom of the dialog box and then on **Close**.
3. Reboot the MOBOTIX camera (**Admin Menu > Reboot Camera**).

Once the camera has rebooted, make sure that the symbol **FR REC** is no longer visible in the bottom right-hand corner of the live image. You can now safely remove the MicroSD card from the camera (see Section 2.2.8, «Replacing the MicroSD Card»).

Caution

A MicroSD card may only be removed from the camera after you have deactivated the recording to MicroSD card and rebooted the camera. **Failing to do so may lead to data loss!**

Removing connected flash storage devices from the camera without properly deactivating them may lead to data loss and/or destroy certain areas of the storage device. This is limited to 4 MB of lost data per incident due to MxFFS formatting.

3.1.1 Using a MicroSD Card in a Different MOBOTIX Camera

A MicroSD card containing recorded video data from a MOBOTIX camera can be inserted into any MicroSD card-enabled MOBOTIX camera. Once a MicroSD card recording has been activated (requires a reboot), the "new" MOBOTIX camera automatically synchronizes with the card and resumes recording. No data is lost in this process. Make sure that you deactivate MicroSD card recording before removing the card and then reboot the MOBOTIX camera.

If the MicroSD card's contents are encrypted, you need to enter the same password in the "new" camera in the **Admin Menu > Storage on External File Server / Flash Device** dialog box. Otherwise, the camera cannot access the MicroSD card.

3.1.2 Limitations on Warranty When Using Flash Storage Media

MOBOTIX will not assume any responsibility for flash storage devices (for example, MicroSD cards or connected USB storage devices) delivered with or integrated into MOBOTIX cameras. The same applies to damage to flash storage devices or damage resulting from the use of devices that are not supplied by MOBOTIX.

3.1 Configuration in the Browser

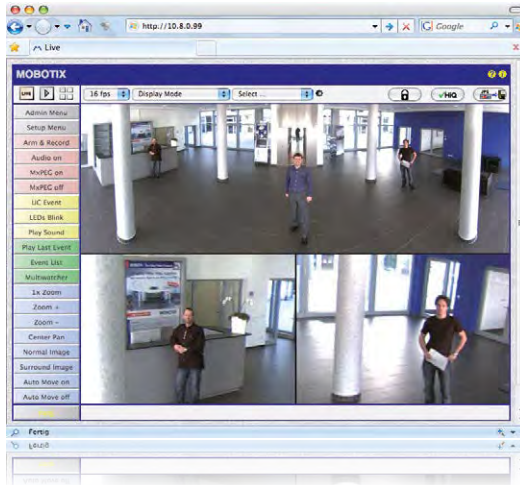

3.1.1 Overview

A MOBOTIX camera can be completely configured using a JavaScript-enabled browser on all common operating systems (such as Windows, Linux, Apple, etc.). The camera provides a HTML-based user interface for this purpose. The camera executes the changes you make to the camera configuration via HTTP commands using programs and scripts of the embedded software. The settings are stored in the camera's flash memory.

This section contains an overview of the basic browser settings of the MOBOTIX camera as well as further configuration options. Detailed information on the software functions is provided in the camera's online help.

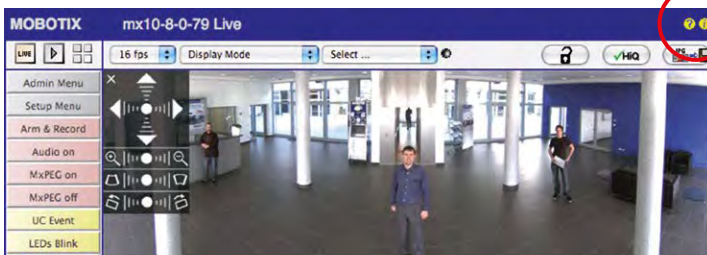

User name: **admin**
password: **meinsm**

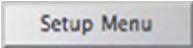

Make sure to permanently store changed parameters!

Automatic time synchronization using a time server

More: Display advanced features

Less: Hide advanced features

Basic Settings

- **Administering the camera:** You can modify the camera configuration in the Admin Menu or the Setup Menu.
 - **Admin Menu:** This menu contains the basic configuration dialog boxes of the camera (for example, passwords, interfaces, software updates).
 - **Setup Menu:** This menu contains the dialog boxes for configuring the image, event and recording parameters. Some of these settings can be changed using the corresponding Quick Controls in the live view.
- **Resetting changes:** If you would like to reset some larger changes in one dialog box without resetting the complete configuration, you can use the **Default** button at the bottom of the dialog box to reset only this dialog box's settings to the factory defaults. If you would like to reset all image settings, you can do so using the **Manage Settings > Restore Image Settings** Quick Control in the live image of the camera.
- **Storing changes permanently:** Once you have finished configuring the camera, you should always store the settings in the camera's permanent memory. You can do so in each dialog box (clicking on the **Set** button at the bottom of each dialog box will temporarily implement the change; when you click **Close**, you will be asked to store the complete configuration in the camera's permanent memory) or in the Admin Menu (**Admin Menu > Store current configuration into flash memory**). The **Configuration** section of the Admin Menu provides more functions for storing, copying and managing camera settings. For more information on this topic, refer to the online help for the specific dialog boxes.
- **Time tasks and time synchronization:** Apart from a multitude of possibilities for controlling the camera using time (time tables, holiday and vacation, scheduled tasks, etc.), the camera can also synchronize its internal clock. This allows you to manually synchronize the camera with a computer or automatically using a time server or another MOBOTIX camera. The camera can use either NTP time servers or Time Protocol servers. For more information on this topic, refer to the online help for the specific dialog boxes.
- **The "More" and "Less" buttons:** When opening some of the camera dialog boxes, the camera only shows the most important parameters. These dialog boxes have a **More** button in the bottom right-hand corner. Click it to display additional options. If all options are displayed, click on the **Less** button to hide the additional options.

3.1.2 General Browser Settings

- **Run the Quick Installation:** After booting a new MOBOTIX camera, accessing the administration menu for the first time will automatically start the Quick Installation assistant (**Admin Menu** button). The Quick Installation assistant helps you in setting the most important parameters of the camera. For security reasons, you should set your own administrator password and disable public access to the camera.
- **Disable public access:** Guest users are only allowed to access the Guest screen of the camera without entering a password. If this is not required, you should deactivate public access (**Admin Menu > Quick Installation** or **Admin Menu > Users and Passwords**).
- **Add users and assign access rights:** Similar to a computer operating system, you can add users and user groups and assign the desired rights (**Admin Menu > Users and Passwords**, **Admin Menu > Group Access Control Lists (ACL)**). This approach allows individual access rights to be assigned or denied to camera-specific features based on the user groups.
- **Deactivate the automatic reboot:** In its factory state, every MOBOTIX camera will automatically reboot at 3:36 a.m. every day. All images in the camera's storage buffer will be deleted during this reboot. Images stored on external file servers, internal flash storage, or SD cards will NOT be affected by this reboot. Make sure that you deactivate the automatic reboot if this is not desired (**Admin Menu > Time Tasks**).
- **Optimize the image settings:** The factory image settings of MOBOTIX cameras deliver excellent images for most application scenarios and should therefore not be changed. If you do wish to make changes, your changes should be minor and gradual. You should, however, set an image program according to the application scenario of the camera. Image programs provide a quick and simple method for adjusting the camera to the application scenario as they perform several configuration steps at once (**Image Programs Quick Control**).
- **Set the resolution of the live image:** By default, all MOBOTIX cameras are factory-set to an image resolution of 640x480 pixels. You can select the desired resolution using the **Resolution Quick Control**.
- **Adjust the exposure:** The automatic exposure control of the MOBOTIX camera uses individually configurable exposure windows to determine the best image exposure. Open the **Exposure Control Quick Control** and select a predefined set of exposure windows. If required, you can also define custom exposure windows (**Setup Menu > Exposure Settings**).
- **Activate event control and recording:** By default, the MOBOTIX camera's event control is disabled. Click on the **Arm & Record** button to activate event control. This will activate motion detection and recording. Cameras with integrated flash memory (MOBOTIX R models and models with an SD card) will automatically use the flash memory to store image and video data (recording target). If desired, you can set additional events and adjust the settings of the recording and storage parameters (**Setup Menu > Event Settings**, **Setup Menu > Recording** and **Admin Menu > Recording to External File Server / Flash Device**).

- **Set up actions/messaging:** Upon detecting an event, the MOBOTIX camera can trigger alarms. These alarms can be adjusted to your needs and you can assign them to a specific event: playing back an alarm sound on the camera speaker, showing the visual alarm in the camera live image, sending an e-mail or network message with the alarm image, placing a phone call, uploading an alarm image to an FTP server, switching a signal output line of the camera (for example, for switching on the lights/opening a door).

For the settings, see **Setup Menu > Action Group Overview**. The actions to be performed are defined and used in these action groups in the form of “action profiles.” The different action profiles can also be defined in the following areas: Admin Menu in the Hardware Configuration (profiles for signal output), Transfer Profiles (FTP, e-mail, network messages) and Sound and VoIP Telephony (sound profiles, VoIP profiles). For more information, refer to the online help for the **Action Group Overview** dialog box.

- **Activate shock detector:** The S26 is also equipped with a shock detector as standard. If, for example, the camera’s housing receives a blow, it automatically registers it and sends a notification via a network message or telephone call. A general advantage is that MOBOTIX cameras are extremely tough because of the absence of mechanical moving parts. This allows them to stay fully operational when they are subject to strong vibrations. Open the **Setup Menu > Event Control > Environment Events > Edit** dialog box if you would like to activate the shock detector (and any other sensors).

3.2 Setting Up an S26 Flex as Door Station

3.2.1 Installation

An S26 Flex can also be installed and configured as a hemispheric door station. Depending on how you want to configure the door station functionality, you have the choice of using different remote stations, bell modules and other accessories.

If you want to use a MOBOTIX S26 as door station, you should download the two manuals IP Video Door Station System Manual Part 1 and Part 2 (www.mobotix.com > Support > Download Center > Documentation > Manuals > IP Video Door Station), since these manuals contain additional information about using the camera as door station.

Required Accessories

- **MX-DoorMaster:** This MxBus module is always required if you intend to operate a door opener via the door station. In addition, the MX-DoorMaster provides the backup power supply for the entire door station using its automatically recharged battery (see www.mobotix.com > Products > Access Control > T26 Outdoor Station and Access Modules).
- **Door bell:**
 - **BellRFID** bell button module with different button sets for the IP Video Door Station (one to five buttons, with or without function button), including transponder cards for keyless entry and operating the mailboxes. This module is connected to the MxBus interface of the S26 using a two-wire cable (cannot be used together with KeypadRFID).
 - **KeypadRFID** keypad module for the IP Video Door Station, which is using numeric codes or transponder cards for keyless entry and operating the mailboxes. This module is connected to the MxBus interface of the S26 using a two-wire cable (cannot be used together with BellRFID).
 - Up to two regular bell buttons connected to the signal inputs of an **MX-232-IO-Box**. The MX-232-IO-Box itself is connected to the MxBus interface of the S26 using a two-wire cable.
- **Remote station:**
 - Computer (Windows or Mac OS X/macOS) with **MxManagementCenter**
 - iOS device (iPhone, iPad, iPad mini, iPod touch) with **MOBOTIX MxBell**
 - **MxDisplay** (remote station with touch panel by MOBOTIX)





Optional Accessories

- **AudioMount** mounting adapter for the S26 with self-adhesive front and pre-installed microphone and speaker. Using this mounting adapter, you can easily attach a S26 to the back of a stainless steel plate or the inside of a letter box, for example (see Section 1.5.11, «AudioMount»).

Notes

Only the new **MX-DoorMaster** (article no. **MX-Door2-INT-PW**) can be used together with the S26! The predecessor T24-DoorMaster (article no. **MX-Door1-INT-PW**) **cannot** be used with an S26.

For installing and wiring these components, follow the same steps as for the MOBOTIX IP Video Door Station. You can find detailed information about wiring as well as the maximum cable lengths in the IP Video Door Station System Manual Part 1 and in the documents BellRFID Quick Installation, KeypadRFID Quick Installation and MX-232-IO-Box Quick Installation www.mobotix.com > **Support** > **Download Center** > **Documentation** > **Manuals**.

3.2.2 Executing the Auto Configuration

Just like with the IP Video Door Station, you can use the camera's **Auto Configuration** to set up the S26 as a door station without a computer. Once all required components have been wired and connected to the S26, you can launch the auto configuration to set up the S26 as a door station.

Start the Auto Configuration

1. Remove the power supply of the camera, then restore the power supply. The camera will execute a reboot and the red LED will light up for 5 to 10 seconds after restoring the power supply.
2. Press the L key. The camera enters the boot menu, ready for selecting one of the boot options.
3. Select the auto configuration (first boot option) by pressing the key longer (> 2 seconds). The camera confirms the selection by flashing rapidly three times.

Set Up a KeypadRFID Module

With this module, the end of the auto configuration is signaled as follows – number keys are flashing white, the **ESC** key is flashing red and the **OK** key is flashing blue.

1. Enter the Super PIN you want to use and add an admin card.
2. Train the user cards as required.

You can find detailed information on setting up the KeypadRFID module in the IP Video Door Station System Manual Part 2 in Section 2.2, «Setting up the Keypad».

Set Up a BellRFID Module

With this module, the end of the auto configuration is signaled as follows – the blue and green status LEDs are flashing and the **OK** button is red.

1. Enter the Super PIN you want to use on the keypad insert and press **OK**. This button turns green and the letter button lights up red.
2. You can select the applicable bell button set by pressing any one of the button contacts in the center.
3. Once you have found the proper pattern, keep any one of the buttons at the center pressed until the LEDs are flashing repeatedly in a sequence. Next, the **OK** and letter buttons light up green and the **ESC** button lights up red.
4. Insert the function and bell buttons as required.
5. Train the admin card. All three LEDs are now green.
6. Train the user cards as required.

You can find detailed information on installing and operating the BellRFID module in the document BellRFID Quick Installation (www.mobotix.com > Support > Download Center > Documentation > Manuals).

Finalize the Setup

The most important functions of the door station are now available. Even the mailbox has been pre-configured. You can make the remaining adjustments – just like with a “regular” IP Video Door Station – without a computer using a Grandstream video phone as remote station or with a computer using MxEasy or a web browser.

6.1 Additional Notes

6.1.1 Reduced Weather Protection When Installing Upside-Down

If you are installing the S26 upside-down (i.e., the connectors are pointing upwards), the camera does not reach protection class IP66 any more, but only IP54. If mounted upside-down, the camera can only be used in a dry indoor environment.



Connectors pointing down



Connectors pointing up

6.1.2 Password for the Admin Menu

Accessing the Administration Menu of the camera (**Admin Menu** softbutton) is only possible after entering a user name and password.

- Factory default user name is **admin**.
- Factory default password is **meinsm**.

(Note that you need to change the password upon your first login – camera release V5.1.x and higher.)

The **Quick Installation** assistant automatically appears when the Administration Menu is accessed for the first time. It provides an easy method to adjust the basic camera settings to the current application scenario. For security reasons, we highly recommend changing the default administrator password after the camera has been properly configured.

Enter the user name and password exactly as shown above. Note that all entries are case-sensitive.

Caution

Make sure that you store information on **user names and passwords** in a secure place. If you lose the administrator password and cannot access the administration menu, the password can only be reset at the factory. This service is subject to a fee!

6.1.3 Permanently Deactivating the Microphone

Deactivating a camera's microphone may be necessary in order to protect the privacy of persons at a workplace or for other reasons. You can permanently and irreversibly deactivate the microphone in the **Admin Menu > Loudspeaker and Microphone** dialog box.

Caution

This **deactivation occurs in the camera module itself and cannot be reversed**, even at the factory. Deactivating the microphone will also deactivate all functions that are making use of the microphone.

6.1.4 Using the Start Options of the Camera

- To **reset the camera to factory settings and to use the factory IP address**, please use **start option 2** as described in Section 4.1.3, «Start Options of the Camera».
- To **start the camera as a DHCP client and to automatically obtain an IP address**, please use **start option 3** as described in Section 4.1.3, «Start Options of the Camera».

The microphone can be irreversibly deactivated!

Note

All defined users are deleted and the admin password is reset to the factory default when you reset the camera using **Admin Menu > Reset**. Use **start option 3** as described in Section 4.1.3, «Start Options of the Camera», if you **do not** want to delete the existing users.

6.2 Activating Event Control and Motion Detection

In its default configuration, the camera's event control and video motion detection features are not enabled. In order to activate event-controlled recording, open **Setup Menu > General Event Settings** and activate the Arming switch. Another method is to click on the **Arm & Record** softbutton in the browser's user interface. The camera displays the motion detection window in the live image (dotted frame in the center) and the camera automatically stores images as soon as the motion detection window detects movements.

6.2.1 Deactivating Text and Logo Options

As camera arming is deactivated in the camera's default configuration (see preceding section), the MOBOTIX camera only displays the text **WWW.MOBOTIX.COM**, the time stamp and the MOBOTIX logo at the top of the image. Once the camera arming has been activated, the text at the bottom of the live image (event, action, messaging and recording symbols) will also appear.

You can deactivate the status bar at the bottom of the live image and the text bar in the top left-hand corner by setting Text Display in the **Setup Menu > Text & Display Settings** dialog box to **Off**. Setting Text Display to **Date and Time** will only display the time stamp in the live image. To hide the logo in the live image, open **Admin Menu > Logo Profiles** and set **Logo Display** to **Deactivated**.

6.2.2 Deactivating the Camera Reboot

By factory default, the MOBOTIX camera automatically reboots once a week between 3 a.m. and 4 a.m. The reason for this is that in some rare cases, external influences (for example, radiation at high altitudes) can sometimes lead to camera malfunctions. The automatic reboot will refresh the camera's memory and will ensure proper operation without requiring any interaction on the part of the user. If desired, you can deactivate the automatic reboot of the camera in the **Admin Menu > Time Tasks** dialog box.

6.2.3 Browser

Current Internet browsers (Internet Explorer, Mozilla Firefox, Safari, Google Chrome, Opera, etc.) with enabled JavaScript can display the camera's live images with their standard settings.



If the dotted rectangle in the live image is visible, the camera is armed

Text and logos can be also deactivated or individually configured

6.2.4 Cleaning the Camera and Lens



If the lens becomes dirty during the installation process, clean the lens using a lint-free cotton cloth. Make sure that the lens is still in focus after cleaning and adjust its focus if required.



Cleaning the Dome

- Always mount and unmount the dome using a soft cotton cloth in order to protect it from being scratched and from getting dirty.
- You should clean the dome at regular intervals. Always use a soft, lint-free cotton cloth for this purpose.
- If the dirt is more persistent, add a mild alcohol-free detergent without abrasive particles.
- Make sure you instruct cleaning personnel on how to clean the camera.

6.2.5 Online Help and Camera Information in the Browser

For more information, see the online help of the camera's browser interface. Click on the  icon to open the camera's online help. Furthermore, detailed information on the camera and its current configuration is displayed in the **Camera Status** dialog box. Click on the  icon to open the relevant page.

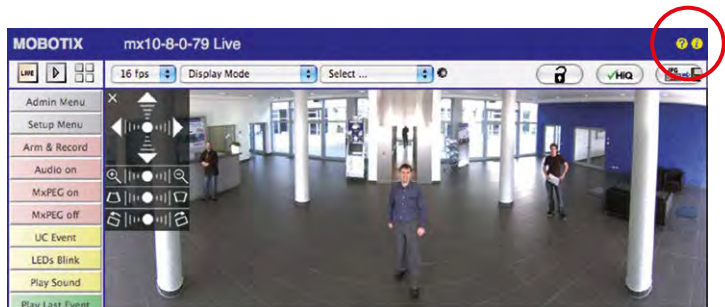

6.2.6 Declaration of Conformity

The products of MOBOTIX AG are certified according to the applicable directives of the E.U. and other countries. You can find the declarations of conformity of the products of MOBOTIX AG under www.mobotix.com, **Support > Download Center > Documentation > Certificates & Declarations of Conformity**.

6.2.7 RoHS Declaration

The products of MOBOTIX AG are in full compliance with Art. 5 of the German Electrical and Electronic Equipment Act and the E.U. Directive 2011/65/EU on the Restriction of the Use of Certain Hazardous Substances in Electrical and Electronic Equipment (RoHS) as far as they are subject to these regulations. (You can find the MOBOTIX RoHS Declaration under www.mobotix.com, **Support > Download Center > Documentation > Certificates & Declarations of Conformity**.)

6.2.8 Disposal

Electrical and electronic products contain many reusable materials. For this reason, we would ask that you dispose of MOBOTIX products at the end of their service life in accordance with all legal requirements and regulations (or deposit these products at a municipal collection center). MOBOTIX products may not be disposed of with household waste! If the product contains a battery, please dispose of the battery separately (the corresponding product manuals contain specific directions if the product contains a battery).



6.2.9 Disclaimer

Neither MOBOTIX AG nor any subsidiary of MOBOTIX AG will assume any responsibility for damage resulting from improper use of its products or failure to comply with the manuals and the applicable rules and regulations.

Our **General Terms and Conditions** apply. You can read the current version of the **General Terms and Conditions** on our website at www.mobotix.com by clicking on the **General Terms and Conditions** link at the bottom of every page.



MOBOTIX

BeyondHumanVision

Manufacturer

MOBOTIX AG
Kaiserstrasse
67722 Langmeil
Germany

Phone: +49 6302 9816-103

Fax: +49 6302 9816-190

www.mobotix.com

sales@mobotix.com

Registration Office: Kaiserslautern Local Court

Registration Number: HRB 3724

Tax Office: Worms-Kirchheimbolanden, Germany

Tax Code: 44/676/0700/4

VAT ID: DE202203501

You can find the latest version of this and other documents (e.g., declarations of conformity) at www.mobotix.com in the **Support > Download Center > Documentation > Manuals** section.



Technical specifications subject to change without notice!

Camera Manual

S26 Flex

